

# Brief Operating Instructions

## **Cerabar PMC11, PMC21, PMP11, PMP21, PMP23**

Process pressure measurement

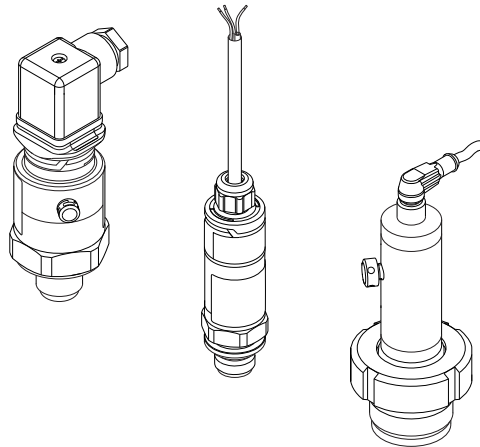

These Instructions are Brief Operating Instructions; they are not a substitute for the Operating Instructions pertaining to the device.

Detailed information about the device can be found in the Operating Instructions and the other documentation:

Available for all device versions via:

- Internet: [www.endress.com/deviceviewer](http://www.endress.com/deviceviewer)
- Smart phone/tablet: *Endress+Hauser Operations App*



A0023555

# Table of contents

<b>1</b>	<b>Document information</b>	<b>4</b>
1.1	Document function	4
1.2	Symbols used	4
1.3	Documentation	5
1.4	Terms and abbreviations	7
1.5	Turn down calculation	8
<b>2</b>	<b>Basic safety instructions</b>	<b>9</b>
2.1	Requirements concerning the staff	9
2.2	Designated use	9
2.3	Workplace safety	10
2.4	Operational safety	10
2.5	Product safety	10
<b>3</b>	<b>Product description</b>	<b>10</b>
<b>4</b>	<b>Incoming acceptance and product identification</b>	<b>11</b>
4.1	Incoming acceptance	11
4.2	Product identification	11
4.3	Storage and transport	12
<b>5</b>	<b>Installation</b>	<b>13</b>
5.1	Installation conditions	13
5.2	Influence of the installation position	13
5.3	Mounting location	14
5.4	Mounting of the profile seal for universal process mounting adapter	14
5.5	Mounting instructions for oxygen applications	14
5.6	Post-installation check	15
<b>6</b>	<b>Electrical connection</b>	<b>15</b>
6.1	Connecting the measuring unit	15
6.2	Switching capacity	18
6.3	Connection conditions	18
6.4	Connection data	18
6.5	Post-connection check	19
<b>7</b>	<b>Operation options</b>	<b>19</b>
7.1	Plug-on display PHX20 (optional)	19





# 1 Document information

## 1.1 Document function



The Brief Operating Instructions contain all the essential information from incoming acceptance to initial commissioning.

## 1.2 Symbols used

### 1.2.1 Safety symbols

Symbol	Meaning
	<b>DANGER!</b> This symbol alerts you to a dangerous situation. Failure to avoid this situation will result in serious or fatal injury.
	<b>WARNING!</b> This symbol alerts you to a dangerous situation. Failure to avoid this situation can result in serious or fatal injury.
	<b>CAUTION!</b> This symbol alerts you to a dangerous situation. Failure to avoid this situation can result in minor or medium injury.
	<b>NOTICE!</b> This symbol contains information on procedures and other facts which do not result in personal injury.









### 1.2.2 Electrical symbols

Symbol	Meaning	Symbol	Meaning
	<b>Protective ground connection</b> A terminal which must be connected to ground prior to establishing any other connections.		<b>Ground connection</b> A grounded terminal which, as far as the operator is concerned, is grounded via a grounding system.



### 1.2.3 Tool symbols

Symbol	Meaning
 A0011222	Open-ended wrench

### 1.2.4 Symbols for certain types of information

Symbol	Meaning	Symbol	Meaning
	<b>Permitted</b> Procedures, processes or actions that are permitted.		<b>Tip</b> Indicates additional information.
	<b>Forbidden</b> Procedures, processes or actions that are forbidden.		Series of steps
	Reference to documentation		Result of a step
	Reference to graphic		Visual inspection
	Reference to page		

### 1.2.5 Symbols in graphics

Symbol	Meaning
	Item numbers
	Series of steps
	Views

## 1.3 Documentation



The document types listed are available:

In the Download Area of the Endress+Hauser Internet site: [www.endress.com](http://www.endress.com) → Download

### 1.3.1 Technical Information (TI): planning aid for your device

PMC11: TI01133P

PMP11: TI01133P

PMC21: TI01133P

PMP21: TI01133P

PMP23: TI01203P

The document contains all the technical data on the device and provides an overview of the accessories and other products that can be ordered for the device.

### 1.3.2 Operating Instructions (BA): your comprehensive reference

BA01271P

These Operating Instructions contain all the information that is required in various phases of the life cycle of the device: from product identification, incoming acceptance and storage, to

mounting, connection, operation and commissioning through to troubleshooting, maintenance and disposal.

### 1.3.3 Safety Instructions (XA)

Depending on the approval, the following Safety Instructions (XA) are supplied with the device. They are an integral part of the Operating Instructions.

Device	Directive	Documentation	Option <sup>1)</sup>
PMP21 PMP23	ATEX II 1/2G Ex ia IIC T4 Ga/Gb	XA01271P	BA
PMC21	ATEX II 2G Ex ia IIC T4 Gb	XA01271P	BB
PMC21 PMP21	ATEX II 3G Ex ec IIC T4 Gc	XA01533P	BC
PMC21 PMP21 PMP23	FM IS Cl. I, Div.1 Gr. A-D T4	XA01321P	FA
PMC21 PMP21 PMP23	CSA C/US IS Cl. I Div. 1 Gr. A-D	XA01322P	CB
PMC21 PMP21 PMP23	EAC Ex ia IIC T4 Ga/Gb	XA01540P	GA
PMC21 PMP21 PMP23	IEC Ex ia IIC T4 Ga/Gb	XA01271P	IA
PMC21 PMP21 PMP23	NEPSI Ex ia IIC T4	XA01363P	NA
PMC21 PMP21 PMP23	TIIS Ex ia IIC T4	In preparation	TA

1) Product Configurator order code for "Approval"



The nameplate indicates the Safety Instructions (XA) that are relevant to the device.

## 1.4 Terms and abbreviations

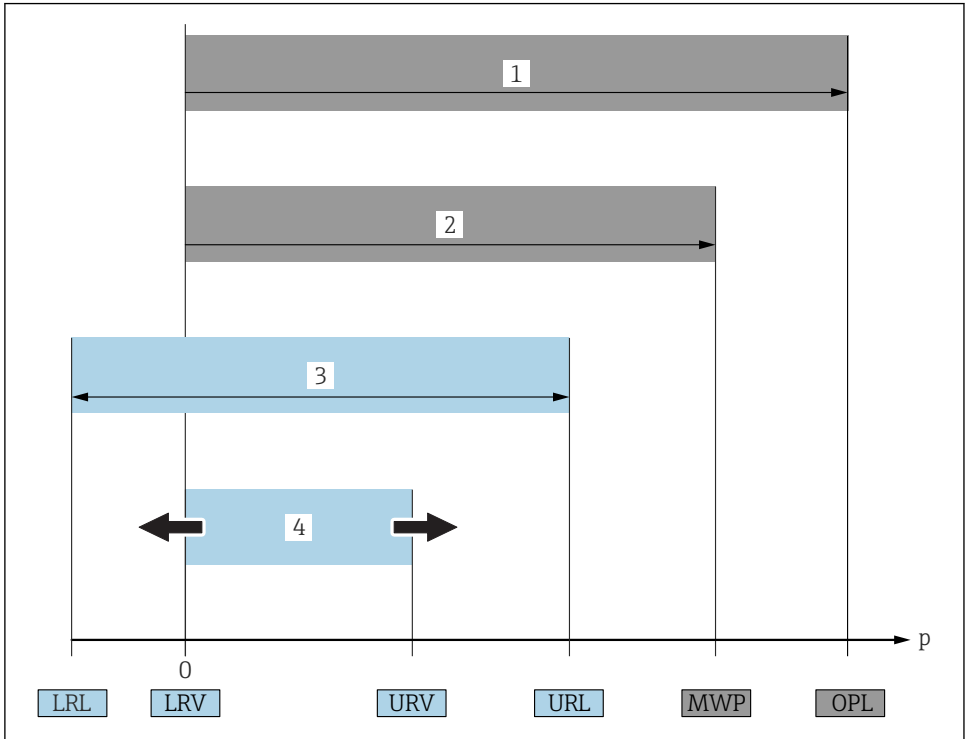

A0029505

Item	Term/abbreviation	Explanation
1	OPL	The OPL (over pressure limit = sensor overload limit) for the measuring device depends on the lowest-rated element, with regard to pressure, of the selected components, i.e. the process connection has to be taken into consideration in addition to the measuring cell. Also observe pressure-temperature dependency. For the relevant standards and additional notes, see the "Pressure specifications" section of the Operating Instructions . The OPL may only be applied for a limited period of time.
2	MWP	The MWP (maximum working pressure) for the sensors depends on the lowest-rated element, with regard to pressure, of the selected components, i.e. the process connection has to be taken into consideration in addition to the measuring cell. Also observe pressure-temperature dependency. For the relevant standards and additional notes, see the "Pressure specifications" section of the Operating Instructions . The MWP may be applied at the device for an unlimited period. The MWP can also be found on the nameplate.
3	Maximum sensor measuring range	Span between LRL and URL This sensor measuring range is equivalent to the maximum calibratable/adjustable span.

Item	Term/ abbreviation	Explanation
4	Calibrated/ adjusted span	Span between LRV and URV Factory setting: 0 to URL Other calibrated spans can be ordered as customized spans.
p	-	Pressure
-	LRL	Lower range limit
-	URL	Upper range limit
-	LRV	Lower range value
-	URV	Upper range value
-	TD (turn down)	Turn down The turn down is preset at the factory and cannot be changed. Example - see the following section.

### 1.5 Turn down calculation

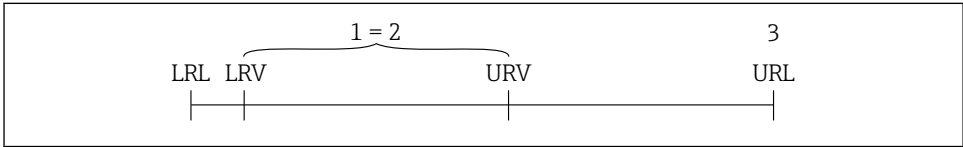

A0029545

- 1 *Calibrated/adjusted span*
- 2 *Zero point-based span*
- 3 *URL sensor*

Example	
<ul style="list-style-type: none"> <li>■ Sensor: 10 bar (150 psi)</li> <li>■ Upper range value (URL) = 10 bar (150 psi)</li> </ul>	<ul style="list-style-type: none"> <li>■ Calibrated/adjusted span: 0 to 5 bar (0 to 75 psi)</li> <li>■ Lower range value (LRV) = 0 bar (0 psi)</li> <li>■ Upper range value (URV) = 5 bar (75 psi)</li> </ul>
Turn down (TD):	
$TD = \frac{URL}{ URV - LRV }$	
$TD = \frac{10 \text{ bar (150 psi)}}{ 5 \text{ bar (75 psi)} - 0 \text{ bar (0 psi)} } = 2$	
<p>In this example, the TD is 2:1. This span is based on the zero point.</p>	



## 2 Basic safety instructions

### 2.1 Requirements concerning the staff

The staff must fulfill the following requirements for their tasks:

- ▶ Trained staff: Must have a qualification which corresponds to their function and tasks.
- ▶ Authorized by the plant operator.
- ▶ Familiar with the national regulations.
- ▶ Before starting their work: Must have read and understood all instructions in the operating manual and supplementary documentation as well as the certificate (depending on the application).
- ▶ Must comply with all instructions and the regulatory framework.

### 2.2 Designated use

#### 2.2.1 Application and media

The Cerabar is used to measure absolute and gauge pressure in gases, vapors and liquids. The process-wetted materials of the measuring device must have an adequate level of resistance to the media.

The measuring device may be used for the following measurements (process variables)

- in compliance with the limit values specified under "Technical data"
- in compliance with the conditions that are listed in additional documentation such as the XA and this manual.

#### Measured process variable

- PMC11: Gauge pressure
- PMP11: Gauge pressure
- PMC21: Gauge pressure or absolute pressure
- PMP21: Gauge pressure or absolute pressure
- PMP23: Gauge pressure or absolute pressure

#### Calculated process variable

Pressure

#### 2.2.2 Incorrect use

The manufacturer is not liable for damage caused by improper or non-designated use.

Verification for borderline cases:

- ▶ For special fluids and fluids for cleaning, Endress+Hauser is glad to provide assistance in verifying the corrosion resistance of process-wetted materials, but does not accept any warranty or liability.

#### 2.2.3 Residual risks

When in operation, the housing may reach a temperature close to the process temperature.

Danger of burns from contact with surfaces!

- ▶ For elevated process temperatures, ensure protection against contact to prevent burns.

## 2.3 Workplace safety

For work on and with the device:

- ▶ Wear the required personal protective equipment according to federal/national regulations.
- ▶ Switch off the supply voltage before connecting the device.

## 2.4 Operational safety

Risk of injury!

- ▶ Operate the device in proper technical condition and fail-safe condition only.
- ▶ The operator is responsible for interference-free operation of the device.

### Conversions to the device

Unauthorized modifications to the device are not permitted and can lead to unforeseeable dangers.

- ▶ If, despite this, modifications are required, consult with Endress+Hauser.

### Hazardous area

To eliminate the risk of danger to persons or the facility when the device is used in the approval-related area (e.g. explosion protection, pressure equipment safety):

- ▶ Check the nameplate to verify if the device ordered can be put to its intended use in the approval-related area.
- ▶ Observe the specifications in the separate supplementary documentation, such as the XA or SD, which is an integral part of these Instructions.

## 2.5 Product safety

This measuring device is designed in accordance with good engineering practice to meet state-of-the-art safety requirements, has been tested, and left the factory in a condition in which it is safe to operate.

It meets general safety standards and legal requirements. It also complies with the EU directives listed in the device-specific EU Declaration of Conformity. Endress+Hauser confirms this by affixing the CE mark to the device.

# 3 Product description

See Operating Instructions.

## 4 Incoming acceptance and product identification

### 4.1 Incoming acceptance

- Is the order code on the delivery note identical to the order code on the product sticker?
- Are the goods undamaged?
- Do the data on the nameplate correspond to the order specifications and the delivery note?
- If required (see nameplate): Are the safety instructions (XA) provided?
- Is the documentation available?



If one of these conditions does not apply, please contact your Endress+Hauser sales office.

### 4.2 Product identification

The following options are available for the identification of the measuring device:

- Nameplate specifications
- Order code with a breakdown of the device features on the delivery note
- Enter the serial numbers from the nameplates in *W@M Device Viewer* ([www.endress.com/deviceviewer](http://www.endress.com/deviceviewer)): All the information about the measuring device is displayed.

For an overview of the technical documentation provided, enter the serial number from the nameplates in *W@M Device Viewer* ([www.endress.com/deviceviewer](http://www.endress.com/deviceviewer))

#### 4.2.1 Manufacturer address

Endress+Hauser SE+Co. KG  
Hauptstraße 1  
79689 Maulburg, Germany

Address of the manufacturing plant: See nameplate.

## 4.2.2 Nameplate

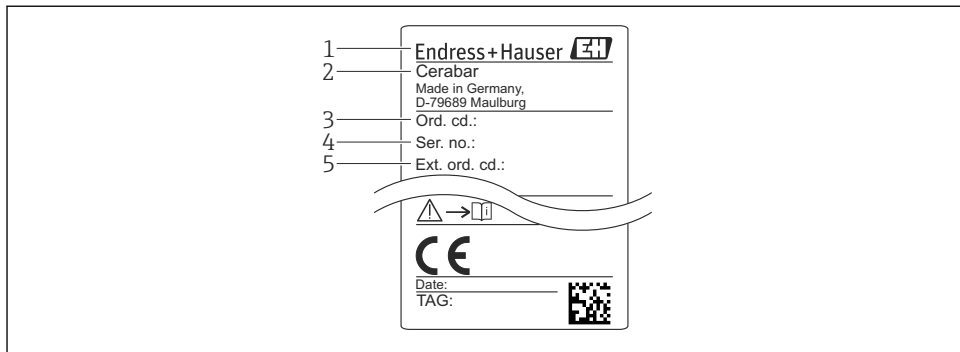

A0024456

- 1 *Manufacturer's address*
- 2 *Device name*
- 3 *Order number*
- 4 *Serial number*
- 5 *Extended order number*

## 4.3 Storage and transport

### 4.3.1 Storage conditions

Use original packaging.

Store the measuring device in clean and dry conditions and protect from damage caused by shocks (EN 837-2).

### Storage temperature range

-40 to +85 °C (-40 to +185 °F)

### 4.3.2 Transporting the product to the measuring point

#### **WARNING**

#### **Incorrect transport!**

Housing and diaphragm may become damaged, and there is a risk of injury!

- ▶ Transport the measuring device to the measuring point in its original packaging or by the process connection.

## 5 Installation

### 5.1 Installation conditions

- Moisture must not penetrate the housing when mounting the device, establishing the electrical connection and during operation.
- For M12 plug made of metal: Do not remove the protection cap (only in IP69 and Ex ec version) of M12 plug connection until shortly before electrical connection.
- Do not clean or touch process isolating diaphragms with hard and/or pointed objects.
- Do not remove process isolating diaphragm protection until shortly before installation.
- Always tighten the cable entry firmly.
- Point the cable and connector downwards where possible to prevent moisture from entering (e.g. rain or condensation water).
- Protect housing against impact.
- For devices with gauge pressure sensor and M12 or valve plug, the following applies:

#### NOTICE

**If a heated device is cooled in the course of a cleaning process (by cold water, for example), a vacuum develops for a short time causing moisture to penetrate the sensor via the pressure compensation element (1).**

Device could be destroyed!

- ▶ In the event of this happening, mount the device in such a way that the pressure compensation element (1) is pointing downwards at an angle or to the side, if possible.

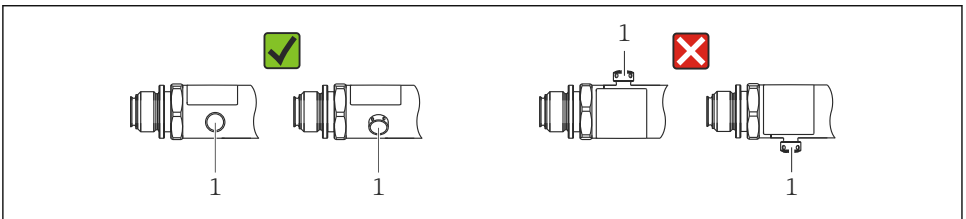

A0022252

### 5.2 Influence of the installation position

Any orientation is possible. However, the orientation may cause a zero point shift i.e. the measured value does not show zero when the vessel is empty or partially full.

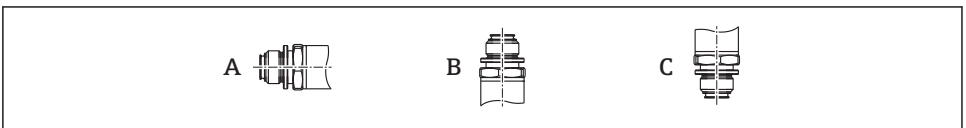

A0024708

Type	Process isolating diaphragm axis is horizontal (A)	Process isolating diaphragm pointing upwards (B)	Process isolating diaphragm pointing downwards (C)
PMP11 PMP21 PMP23	Calibration position, no effect	Up to +4 mbar (+0.058 psi)	Up to -4 mbar (-0.058 psi)
PMC11, PMC21 < 1 bar (15 psi)	Calibration position, no effect	Up to +0.3 mbar (+0.0044 psi)	Up to -0.3 mbar (-0.0044 psi)
PMC11, PMC21 ≥1 bar (15 psi)	Calibration position, no effect	Up to +3 mbar (+0.0435 psi)	Up to -3 mbar (-0.0435 psi)

## 5.3 Mounting location

### 5.3.1 Pressure measurement

#### Pressure measurement in gases

Mount the device with shutoff device above the tapping point so that any condensate can flow into the process.

#### Pressure measurement in vapors

For pressure measurement in vapors, use a siphon. The siphon reduces the temperature to almost ambient temperature. Mount the device with a shutoff device at the same height as the tapping point.

Advantage:

only minor/negligible heat effects on the device.

Note the max. permitted ambient temperature of the transmitter!

#### Pressure measurement in liquids

Mount the device with a shutoff device at the same height as the tapping point.

### 5.3.2 Level measurement

- Always install the device below the lowest measuring point.
- Do not install the device at the following positions:
  - In the filling curtain
  - In the tank outlet
  - in the suction area of a pump
  - Or at a point in the tank which could be affected by pressure pulses from the agitator.

## 5.4 Mounting of the profile seal for universal process mounting adapter

For details on mounting, see KA00096F/00/A3.

## 5.5 Mounting instructions for oxygen applications

See Operating Instructions.

## 5.6 Post-installation check

<input type="checkbox"/>	Is the device undamaged (visual inspection)?
<input type="checkbox"/>	Does the device comply with the measuring point specifications? For example: <ul style="list-style-type: none"> <li>▪ Process temperature</li> <li>▪ Process pressure</li> <li>▪ Ambient temperature range</li> <li>▪ Measuring range</li> </ul>
<input type="checkbox"/>	Are the measuring point identification and labeling correct (visual inspection)?
<input type="checkbox"/>	Is the device adequately protected against precipitation and direct sunlight?
<input type="checkbox"/>	Are the securing screws tightened securely?
<input type="checkbox"/>	Is the pressure compensation element pointing downwards at an angle or to the side?
<input type="checkbox"/>	To prevent moisture from penetrating, ensure that the connecting cables/plugs are pointing downwards.

## 6 Electrical connection

### 6.1 Connecting the measuring unit

#### 6.1.1 Terminal assignment

#### **WARNING**

#### **Risk of injury from the uncontrolled activation of processes!**

- ▶ Switch off the supply voltage before connecting the device.
- ▶ Make sure that downstream processes are not started unintentionally.

#### **WARNING**

#### **Supply voltage might be connected!**

#### Risk of explosion!

- ▶ Make sure that no supply voltage is applied when connecting.
- ▶ Switch off the supply voltage before connecting the device.

**⚠ WARNING****Limitation of electrical safety due to incorrect connection!**

- ▶ In accordance with IEC/EN61010 a separate circuit breaker must be provided for the device .
- ▶ The device must be operated with a 500 mA fine-wire fuse (slow-blow).
- ▶ When using the measuring device in hazardous areas, installation must comply with the corresponding national standards and regulations and the Safety Instructions or Installation or Control Drawings.
- ▶ All explosion protection data are given in separate documentation which is available upon request. The Ex documentation is supplied as standard with all devices approved for use in explosion hazardous areas.
- ▶ Protective circuits against reverse polarity are integrated.

Connect the device in the following order:

1. Check that the supply voltage corresponds to the supply voltage indicated on the nameplate.
2. Connect the device in accordance with the following diagram.

Switch on the supply voltage.

For devices with a cable connection: do not close reference air hose (see (a) in the following drawings)! Protect reference air hose against penetration by water/condensate.

*4 to 20 mA output*

Device	M12 plug	Valve plug	Cable
PMC11 PMP11 PMC21 PMP21 PMP23			<p>           1 brown = L+            2 blue = L-            3 green/yellow = ground connection            (a) reference air hose         </p>

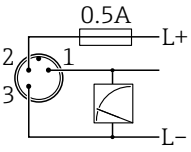
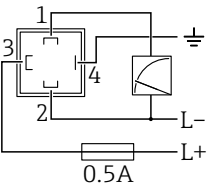

0 to 10 V output

Device	M12 plug	Valve plug	Cable
PMC11 PMP11	 <p>A0017576</p>	 <p>A0022822</p>	-

6.1.2 Supply voltage



**Supply voltage might be connected!**

Risk of explosion!

- ▶ When using the measuring device in hazardous areas, installation must comply with the corresponding national standards and regulations as well as the Safety Instructions.
- ▶ All explosion protection data are given in separate documentation which is available upon request. The Ex documentation is supplied as standard with all devices approved for use in explosion hazardous areas.

Electronic version	Device	Supply voltage
4 to 20 mA output	PMC11 PMP11 PMC21 PMP21 PMP23	10 to 30 V DC
0 to 10 V output	PMC11 PMP11	12 to 30 V DC

6.1.3 Current consumption and alarm signal

Number of wires	Device	Normal operation	Alarm signal <sup>1)</sup>
2	PMC11 PMP11 PMC21 PMP21 PMP23	≤ 26 mA	> 21 mA
3	PMC11 PMP11	< 12 mA	11 V

1) For MAX alarm (factory setting)

## 6.2 Switching capacity

- Switch cycles: >10,000,000
- Voltage drop PNP:  $\leq 2$  V
- Overload protection: Automatic load testing of switching current;
  - Max. capacitive load: 14  $\mu$ F at max. supply voltage (without resistive load)
  - Max. cycle duration: 0.5 s; min.  $t_{on}$ : 4 ms
  - Periodic disconnection from protective circuit in the event of overcurrent ( $f = 2$  Hz) and "F804" displayed

## 6.3 Connection conditions

### 6.3.1 Cable specification

For valve plug: < 1.5 mm<sup>2</sup> (16 AWG) and  $\varnothing$ 4.5 to 10 mm (0.18 to 0.39 in)

## 6.4 Connection data

### 6.4.1 Load (for 4 to 20 mA devices)

In order to guarantee sufficient terminal voltage in two-wire devices, a maximum load resistance  $R_L$  (including line resistance) must not be exceeded depending on the supply voltage  $U_B$  of the supply unit.

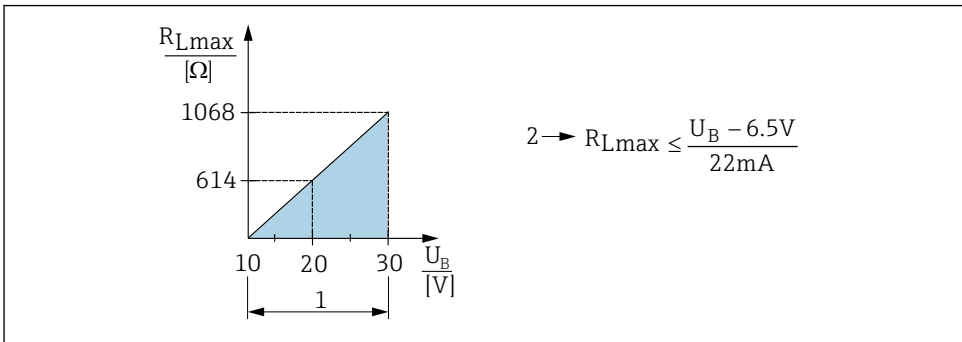

A0029452

- 1 Power supply 10 to 30 VDC  
 2  $R_{Lmax}$  Maximum load resistance  
 $U_B$  Supply voltage

### 6.4.2 Load resistance (for 0 to 10 V devices)

The load resistance must be  $\geq 5$  [k $\Omega$ ].

## 6.5 Post-connection check

<input type="checkbox"/>	Is the device or cable undamaged (visual check)?
<input type="checkbox"/>	Do the cables comply with the requirements?
<input type="checkbox"/>	Do the mounted cables have adequate strain relief?
<input type="checkbox"/>	Are all the cable glands installed, firmly tightened and leak-tight?
<input type="checkbox"/>	Does the supply voltage match the specifications on the nameplate?
<input type="checkbox"/>	Is the terminal assignment correct ?
<input type="checkbox"/>	If required: has protective ground connection been established?

## 7 Operation options

### 7.1 Plug-on display PHX20 (optional)

Devices with valve plug can be fitted with the optional local display PHX20.

A 1-line liquid crystal display (LCD) is used. The local display shows measured values, fault messages and information messages. The device display can be turned in 90° steps. Depending on the orientation of the device, it is therefore easy to read the measured values.

#### 7.1.1 Storage conditions

- Use original packaging.
- Storage temperature range: -30 to +80 °C (-22 to +176 °F)

#### 7.1.2 Installation

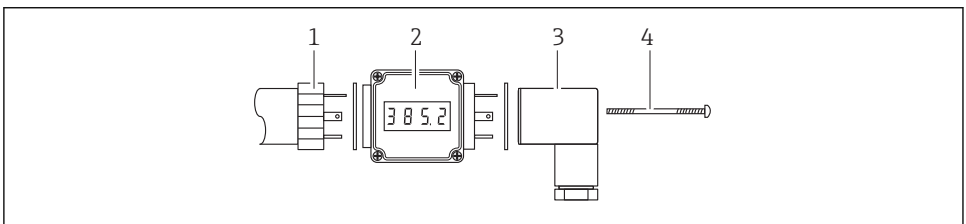

A0022208

1. Place seals between the sensor and plug-on display and between the plug-on display and plug.
2. Insert plug-on display (2) between plug (3) and plug socket (1) of sensor.
3. Replace securing screw (4) with the extended screw that is included in the scope of delivery.

4. An adhesive label specifying the technical unit, which is included in the scope of delivery, can be applied below the LED display.

### 7.1.3 Technical data

See Operating Instructions.

### 7.1.4 Electrical connection

#### Pin assignment

#### WARNING

#### Is the supply voltage switched off?

Risk of electric shock!

- ▶ Switch off the supply voltage before connecting the device.

- PIN 1: L+ (supply voltage  $U_B$ )
- PIN 2: L- (0 V)
- PIN 3: not used

#### Supply voltage

The supply voltage (usually 24 V DC) must be greater than the sum of the voltage drop  $U_s$  at the sensor, voltage drop 5 V at the display and other voltage losses  $U_a$  (such as additional analysis and line losses).

The following therefore applies:  $U_b = U_s + 5 \text{ V} + U_a$

#### Post-connection check

<input type="checkbox"/>	Is the device or cable undamaged (visual check)?
<input type="checkbox"/>	Are all cable glands installed, securely tightened and leak-tight?
<input type="checkbox"/>	If supply voltage is present, is the device ready for operation and do values appear on the display module?

### 7.1.5 Commissioning

#### WARNING

#### Risk of injury from the uncontrolled activation of processes!

- ▶ Ensure that no uncontrolled processes are activated in the system.

#### Configuring menu items

To configure, release the four Phillips screws (1) on the display and remove the cover.

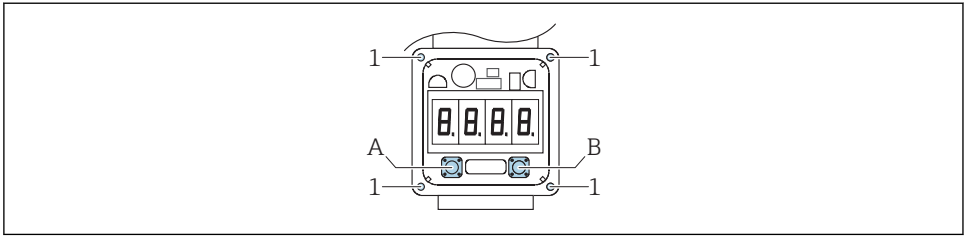

A0022209

*A* Scroll downwards in menu and select menu items

*B* Scroll upwards in menu and select menu items

*A+B* Select menu item to make or confirm the setting

### **Setting the decimal point**

See Operating Instructions.

### **Setting the range overshoot**

See Operating Instructions.







71404628

[www.addresses.endress.com](http://www.addresses.endress.com)

---