

Technical Information

Liquiphant FTL33

Vibronic

Point level switch for liquids in the food sector



Application

The Liquiphant FTL33 is a point level switch for universal use in all liquids. It is used preferably in storage tanks, mixing vessels and pipes, where the internal and external hygiene requirements are particularly stringent.

Ideal for applications in which float switches or conductive, capacitance and optical sensors have been used up to now. The Liquiphant FTL33 also works in areas where these measuring principles are not suitable due to conductivity, buildup, turbulence, flow conditions or air bubbles.

The Liquiphant FTL33 can be used for process temperatures up to:

- 100 °C (212 °F), CIP-capable
- 150 °C (302 °F), CIP- and SIP-capable

Your benefits

- 3-A and EHEDG certificates
- CIP and SIP cleanability guaranteed up to 150 °C (302 °F) continuous temperature
- All-metal separation, no plastics in the process
- Robust stainless steel housing, optionally available with M12x1 connector with IP69K protection (optional)
- External function test with test magnet
- Onsite function check possible thanks to LED indication
- Compact design for easy installation even in confined conditions or hard-to-access areas





Table of contents

Document information	3	Process	17
Document conventions	3	Process temperature range	17
Function and system design	4	Process pressure range	17
Measuring principle	4	Density	17
Measuring system	4	State of aggregation	17
Input	5	Viscosity	17
Measured variable	5	Solids contents	17
Measuring range	5	Lateral loading capacity	17
Output	5	Mechanical construction	18
Switch output	5	Design	18
Operating modes	5	Connector	19
Power supply	5	Tuning fork	19
Supply voltage	5	Sensor type	20
Power consumption	5	Weight	24
Current consumption	5	Materials	24
Residual ripple	5	Surface roughness	25
Electrical connection	6	Operability	26
Electronic version 3-wire DC-PNP	7	LED display	26
Electronic version 2-wire AC/DC	9	Function test with test magnet	26
Overvoltage protection	10	Certificates and approvals	27
Performance characteristics	11	CE mark	27
Reference operating conditions	11	C-Tick symbol	27
Switch point	11	Approval	27
Hysteresis	11	Hygienic compatibility	27
Non-repeatability	11	Hygiene approval	28
Influence of ambient temperature	11	Overfill prevention	28
Influence of medium temperature	11	CRN approval	28
Influence of medium pressure	11	Inspection certificates	28
Switching delay	11	Manufacturer declarations	28
Switch-on delay	11	Pressure Equipment Directive	28
Measuring frequency	11	Other standards and guidelines	28
Measured error	11	Ordering information	29
Installation	12	Product Configurator	29
Orientation	12	Services (optional)	29
Installation instructions	12	Accessories	30
Length of connecting cable	14	Process adapter M24	30
Environment	15	Weld-in adapter	31
Ambient temperature range	15	Slotted nut	31
Storage temperature	15	Plug-in jack, cable	31
Climate class	15	Additional accessories	32
Altitude	15	Supplementary documentation	33
Degree of protection	16	Operating Instructions	33
Shock resistance	16	Additional documentation	33
Vibration resistance	16	Certificates	33
Cleaning	16		
Electromagnetic compatibility	16		
Reverse polarity protection	16		
Short-circuit protection	16		



Document information

Document conventions





Safety symbols

Symbol	Meaning
 <small>A0011189-EN</small>	DANGER! This symbol alerts you to a dangerous situation. Failure to avoid this situation will result in serious or fatal injury.
 <small>A0011190-EN</small>	WARNING! This symbol alerts you to a dangerous situation. Failure to avoid this situation can result in serious or fatal injury.
 <small>A0011191-EN</small>	CAUTION! This symbol alerts you to a dangerous situation. Failure to avoid this situation can result in minor or medium injury.
 <small>A0011192-EN</small>	NOTE! This symbol contains information on procedures and other facts which do not result in personal injury.

Electrical symbols

Symbol	Meaning
 <small>A0011200</small>	Ground connection A grounded terminal which, as far as the operator is concerned, is grounded via a grounding system.
 <small>A0011199</small>	Protective ground connection A terminal which must be connected to ground prior to establishing any other connections.

Symbols for certain types of information

Symbol	Meaning
 <small>A0011182</small>	Permitted Indicates procedures, processes or actions that are permitted.
 <small>A0011184</small>	Forbidden Indicates procedures, processes or actions that are forbidden.
 <small>A0011193</small>	Tip Indicates additional information.
 <small>A0011194</small>	Reference to documentation Refers to the corresponding device documentation.
 <small>A0011195</small>	Reference to page Refers to the corresponding page number.

Symbols in graphics

Symbol	Meaning
1, 2, 3 ...	Item numbers
A, B, C, ...	Views

Function and system design

Measuring principle

A piezoelectric drive causes the tuning fork of the Liquiphant FTL33 to vibrate at its resonance frequency. When the tuning fork is immersed in a liquid, its intrinsic frequency changes due to the change in density of the surrounding medium. The electronics system in the point level switch monitors the resonance frequency and indicates whether the tuning fork is vibrating in air or is covered by liquid.

A signal is output via the DC-PNP or AC/DC electrical connection.

Measuring system

The measuring system consists of a Liquiphant FTL33 point level switch, e.g. for connection to programmable logic controllers (PLC), a mini-contactor or solenoid valve.

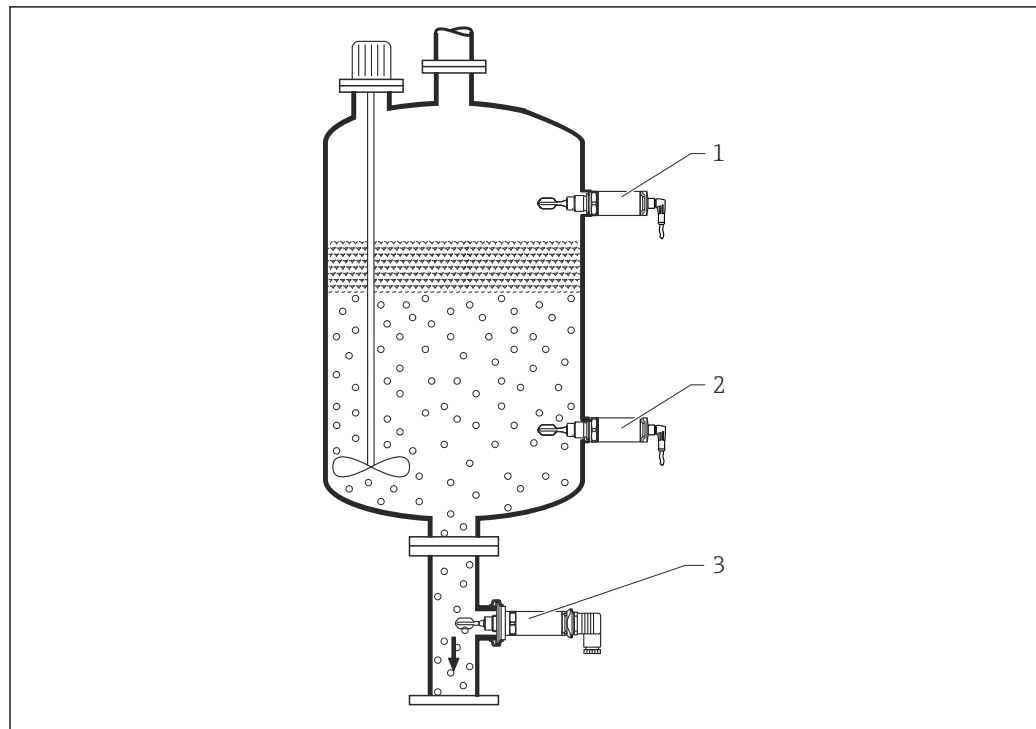

A0020911

- 1 Overfill prevention or upper level detection MAX (maximum safety)
- 2 Lower level detection MIN (minimum safety)
- 3 Lower level detection MIN, e.g. dry running protection for pump

Input

Measured variable	Density
Measuring range	> 0.7 g/cm ³ (optionally available: > 0.5 g/cm ³)

Output

Switch output	Switching behavior: On/Off Function 3-wire DC-PNP: Positive voltage signal at the switch output of the electronics (PNP), switching capacity 200 mA 2-wire AC/DC: Load switching in the power supply line, switching capacity 250 mA
Operating modes	The device has two operating modes: maximum safety (MAX) and minimum safety (MIN). By choosing the corresponding operating mode, the user ensures that the device also switches in a safety-oriented manner even in an alarm condition, e.g. if the power supply line is disconnected. <ul style="list-style-type: none">▪ Maximum safety (MAX) The device keeps the electronic switch closed as long as the liquid level is below the fork. Sample application: overflow prevention▪ Minimum safety (MIN) The device keeps the electronic switch closed as long as the fork is immersed in liquid. Sample application: Dry running protection for pumps The electronic switch opens if the limit is reached, if a fault occurs or the power fails (quiescent current principle).

Power supply

Supply voltage	DC-PNP: 10 to 30 V DC, 3-wire AC/DC: 20 to 253 V AC/DC, 2-wire
Power consumption	DC-PNP: < 975 mW AC/DC: < 850 mW
Current consumption	DC-PNP: < 15 mA AC/DC: < 3.8 mA
Residual ripple	DC-PNP: 5 Vss 0 to 400 Hz AC/DC: –

Electrical connection

Two electronic versions and three different connections are available for the device. A fine-wire fuse is necessary for operation: 500 mA slow-blow.

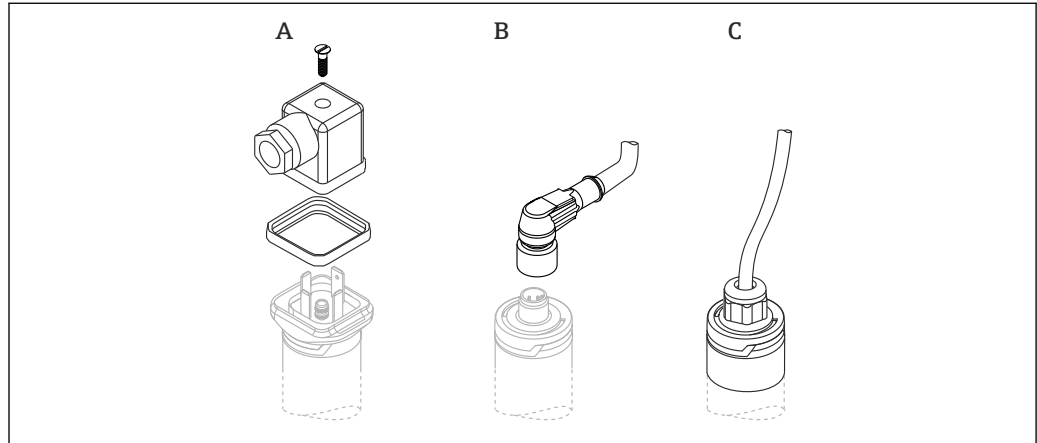
Cable entry

A Valve plug (M16x1.5; NPT ½"; QUICKON)

B M12 connector

C Cable 5 m (16 ft); 10 m (33 ft), captive when delivered, cannot be dismantled

Cable specification

- Valve plug
 - Cable cross-section: max. 1.5 mm² (AWG 16)
 - Ø 3.5 to 8 mm (0.14 to 0.26 in)
- M12 connector: IEC 60947-5-2
- Cable (3LPE)
 - Cable cross-section: 0.75 mm² (AWG 20)
 - Ø 6 to 8 mm (0.24 to 0.31 in)
 - Material: PUR



Electronic version 3-wire DC-PNP



3-wire DC-PNP is preferably used in conjunction with programmable logic controllers (PLC), DI modules as per EN 61131-2. Positive signal at the switch output of the electronics (PNP).

Voltage source: non-hazardous contact voltage or Class 2 circuit (North America).

M12 connector

Depending on the analysis of the switch outputs, the device works in the MAX (maximum safety) or MIN (minimum safety) mode.

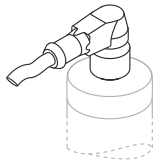
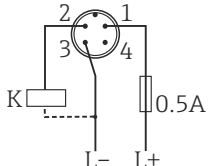
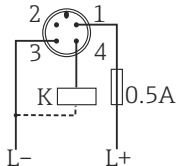

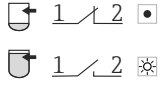



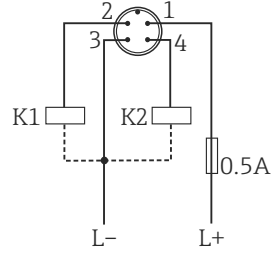
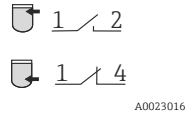

 A cable is optionally available for order, see "Accessories" section (→  31).

Electrical connection	Operating mode	
 <small>A0022901</small>	MAX  <small>A0022858</small>	MIN  <small>A0022859</small>
	 Yellow LED (ye) not lit  Yellow LED (ye) lit K external load	 <small>A0021416</small>

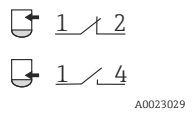
Function monitoring with M12 connector

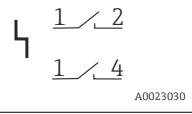

Using a two-channel analysis, function monitoring of the sensor can be implemented in addition to level monitoring, e.g. per relay switch, PLC, AS-i Bus I/O module, ...).

When both outputs are connected, the MIN and MAX outputs assume opposite states when the device is operating fault-free (XOR). In the event of an alarm condition or a line break, both outputs are deenergized.

Connection for function monitoring with antivalence	Yellow LED (ye)	Red LED (rd)
 <small>A0022917</small>	Sensor covered  <small>A0023016</small>	
	Sensor exposed  <small>A0023029</small>	
	Fault  <small>A0023030</small>	
 LED lit  LED not lit  Fault or warning K1 / K2 external load		

Valve plug, cable

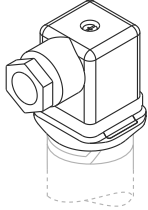
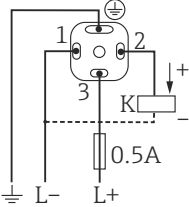
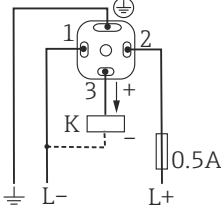
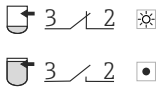
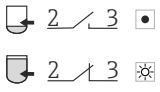
Depending on the assignment of the connector or the wiring of the cable, the device works in either the MAX or MIN operating mode.

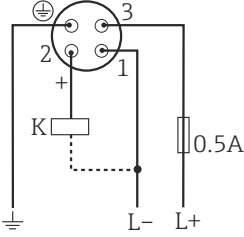
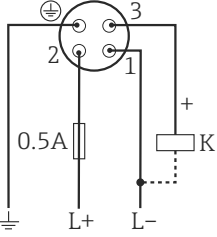
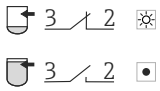
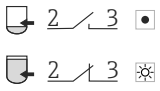
Electrical connection	Operating mode	
 <p>A0022900</p>	<p>MAX</p>  <p>A0021724</p>	<p>MIN</p>  <p>A0021723</p>
	 <p>A0021413</p>	 <p>A0021414</p>
 <p>A0022902</p>	 <p>A0022226</p>	 <p>A0022227</p>
	 <p>A0021413</p>	 <p>A0021414</p>
<p>Core colors: 1 = BK (black) 2 = GR (gray) 3 = BN (brown) Ground = GNYE (green-yellow)</p>		
<p> <input type="checkbox"/> Yellow LED (ye) not lit <input checked="" type="checkbox"/> Yellow LED (ye) lit K external load </p>		

**Electronic version 2-wire
AC/DC**

The load is switched via an electronic switch directly in the power supply circuit. Always connect in series with a load!

Not suitable for connection to low-voltage PLC inputs!

Selection tool for relays

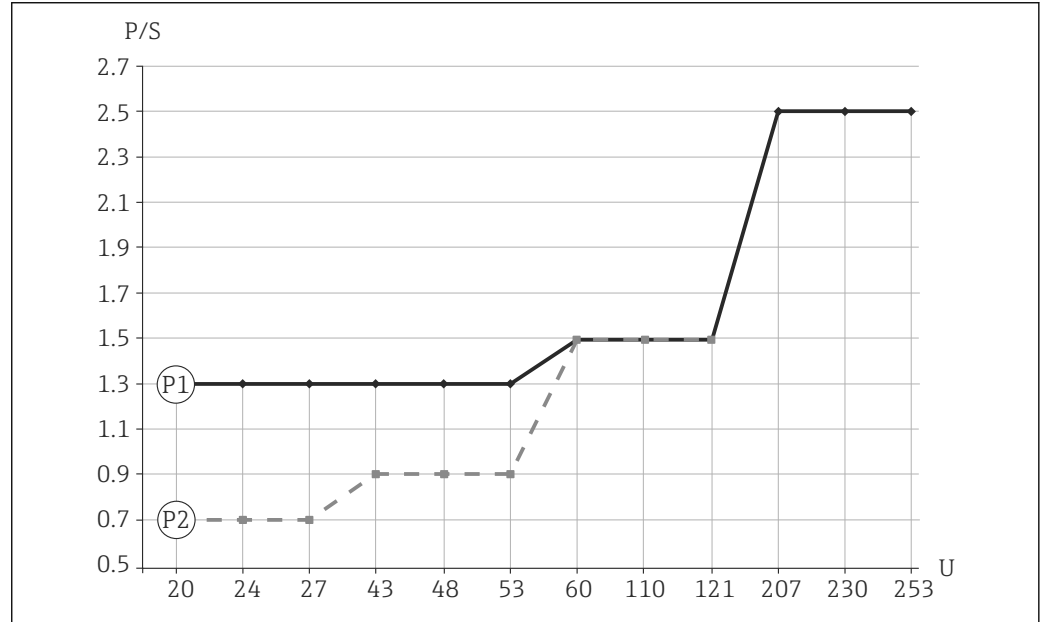

1 Minimum rated power of the load

P/S Rated power in [W] / [VA]

U Operating voltage in [V]





Position	Supply voltage	Rated power	
		min	max
P1 AC mode	24 V	> 1.3 VA	< 6 VA
	110 V	> 1.5 VA	< 27.5 VA
	230 V	> 2.5 VA	< 57.5 VA
P2 DC mode	24 V	> 0.7 W	< 6 W
	48 V	> 0.9 W	< 12 W
	60 V	> 1.5 W	< 15 W

Relays with a lower rated power can be operated by means of an RC module connected in parallel (optional).

Valve plug, cable

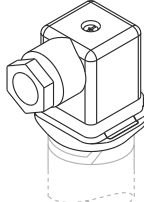
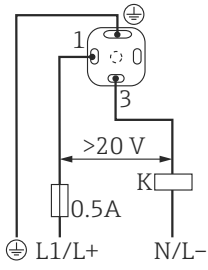
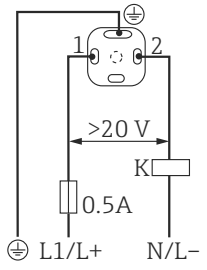
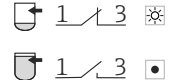
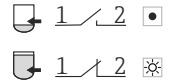
Depending on the assignment of the connector or the wiring of the cable, the device works in either the MAX or MIN operating mode.

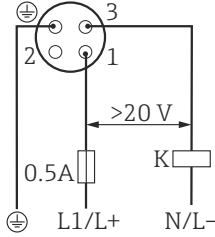
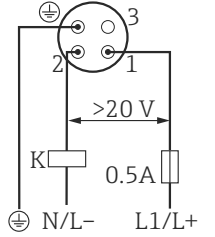
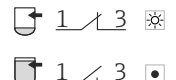
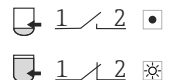
When the cable is wired, one wire of the cable does not have any function in each of the operating modes (brown in the case of MIN, and gray in the case of MAX). The cable with no function must be secured against inadvertent contact.

Electrical connection	Operating mode	
<p>Valve plug</p>  <p style="text-align: right;">A0022900</p>	<p style="text-align: center;">MAX</p>  <p style="text-align: right;">A0021219</p>	<p style="text-align: center;">MIN</p>  <p style="text-align: right;">A0021220</p>
	 <p style="text-align: right;">A0021418</p>	 <p style="text-align: right;">A0021420</p>
<p>Cable (cannot be dismantled)</p>  <p style="text-align: right;">A0022902</p> <p>Core colors: 1 = BK (black) 2 = GR (gray) 3 = BN (brown) Ground = GNYE (green-yellow)</p>	 <p style="text-align: right;">A0022161</p>	 <p style="text-align: right;">A0022225</p>
	 <p style="text-align: right;">A0021418</p>	 <p style="text-align: right;">A0021420</p>
<p>  Yellow LED (ye) not lit  Yellow LED (ye) lit K external load </p>		

Overvoltage protection

Overvoltage category II

Performance characteristics

Reference operating conditions	Ambient temperature:	+25 °C (+77 °F)
	Process pressure:	1 bar (14.5 psi)
	Fluid:	Water (density: approx. 1 g/cm ³ , viscosity 1 mm ² /s)
	Medium temperature:	25 °C (77 °F)
	Density setting:	> 0.7 g/cm ³
	Switching time delay:	Standard (0.5 s, 1 s)
Switch point	13 mm (0.51 in)±1 mm	
Hysteresis	max. 3 mm (0.12 in)	
Non-repeatability	±1 mm (0.04 in) in accordance with DIN 61298-2	
Influence of ambient temperature	Negligible	
Influence of medium temperature	-25 µm (984 µin)/°C	
Influence of medium pressure	-20 µm (787 µin)/bar	
Switching delay	<ul style="list-style-type: none"> ■ 0.5 s when tuning fork is covered ■ 1.0 s when tuning fork is uncovered ■ Optionally available: 0.2 s; 1.5 s or 5 s (when the tuning fork is covered and uncovered) 	
Switch-on delay	max. 3 s	
Measuring frequency	approx. 1 100 Hz in air	
Measured error	In event of device change: ±2 mm (0.08 in) as per DIN 61298-2	

Installation

Orientation

The point level switch can be installed in any position in a vessel, pipe or tank. Foam formation does not affect the function.

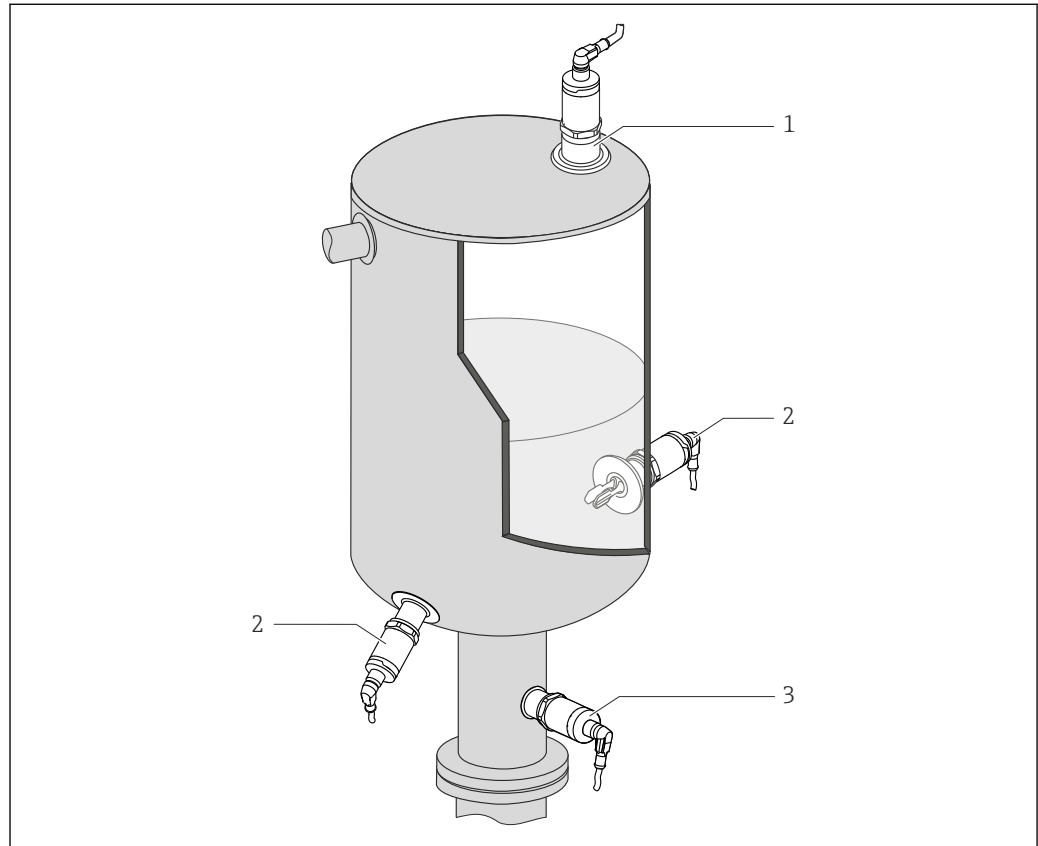

A0029118

2 Installation options

- 1 Overfill prevention or upper level detection
- 2 Lower level detection
- 3 Dry running protection for pump

Installation instructions

Switch point

The switch point (A) on the sensor depends on the orientation of the point level switch (water +25 °C (+77 °F), 1 bar (14.5 psi)).

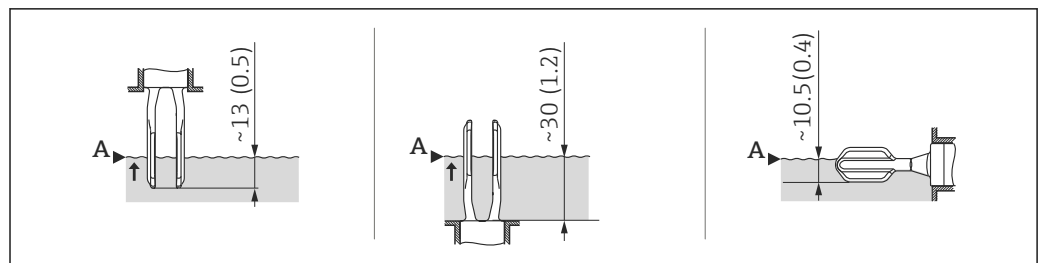

A0020734

3 Vertical and horizontal orientation, dimensions in mm (in)

Short tube version

The use of the short tube ensures that the switch point is at the same level as in the previous Liquiphant FTL260 and FTL330 models when an identical thread is selected. In this way, the device can be replaced quickly and easily. (Applies for process connections G 1" weld-in adapter for flush-mounted installation and MNPT 1")

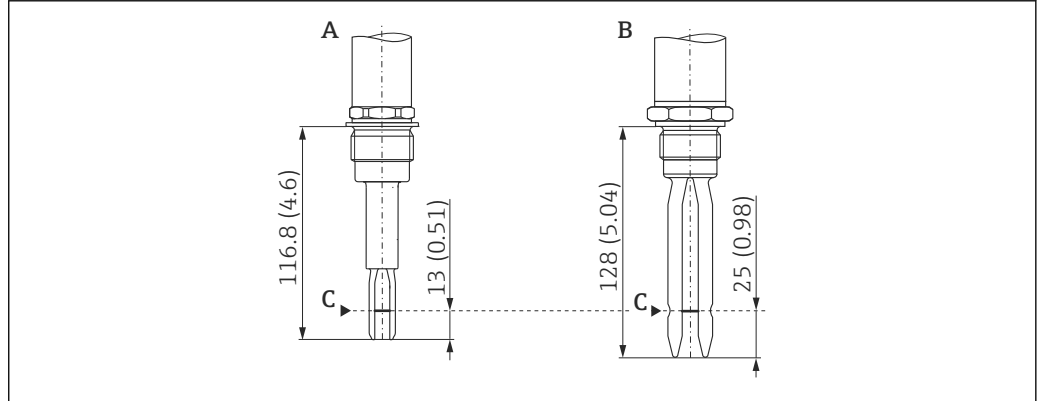

A0022122

- Dimensions mm (in)
- A Liquiphant FTL33 with short tube
 - B Liquiphant FTL260 or FTL330
 - C Switch point

Installation in pipes

During installation, pay attention to the position of the fork in order to minimize turbulence in the pipe.

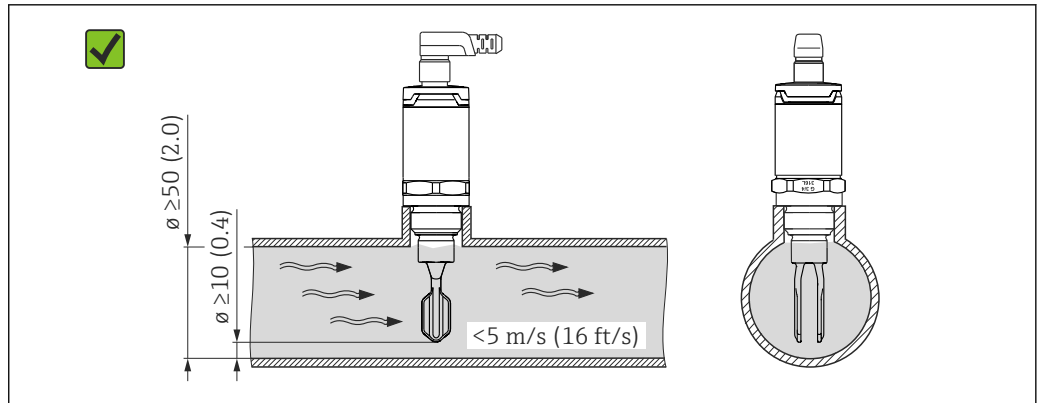

A0021357

Dimensions mm (in)

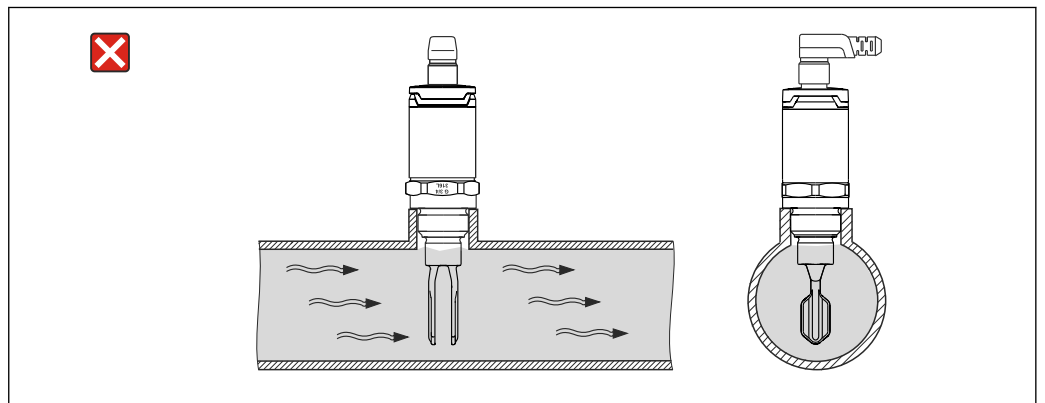

A0022268

Installation in vessels

If installed horizontally, pay attention to the position of the tuning fork to ensure that the liquid can drip off easily.

The electrical connection, e.g. M12 connector, should be pointing down with the cable. This can prevent moisture from penetrating.

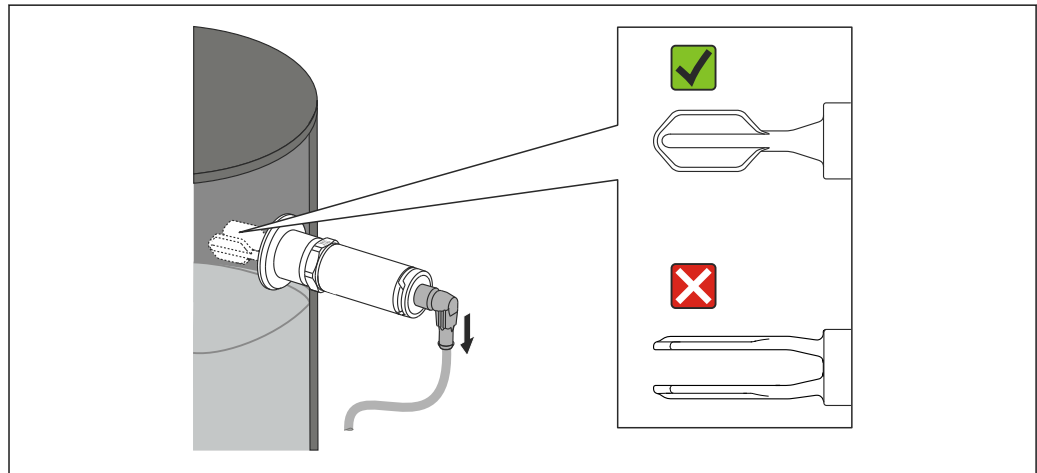

A0021034

4 Position of the fork in the case of horizontal installation in a vessel

Distance from wall

Ensure that there is sufficient distance between the expected buildup on the tank wall and the fork. Recommended distance from wall ≥ 10 mm (0.39 in).

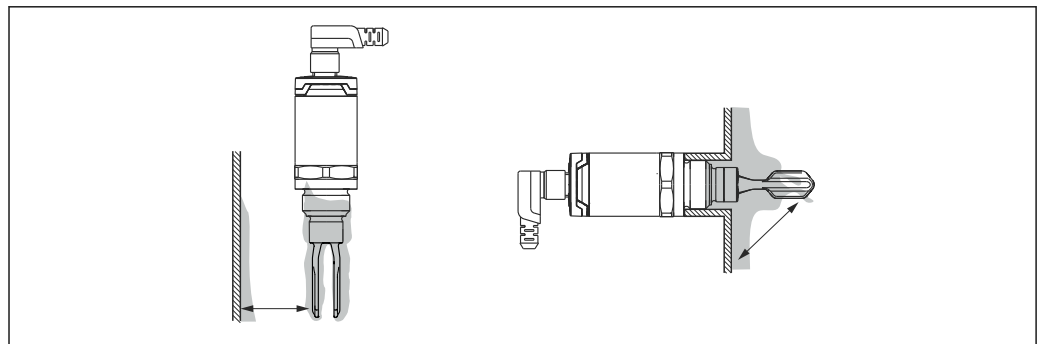

A0022272

Length of connecting cable

- to 1 000 m (3 281 ft)
- max. 25 Ω /wire, total capacitance < 100 nF

Environment

Ambient temperature range -40 to +70 °C (-40 to +158 °F)

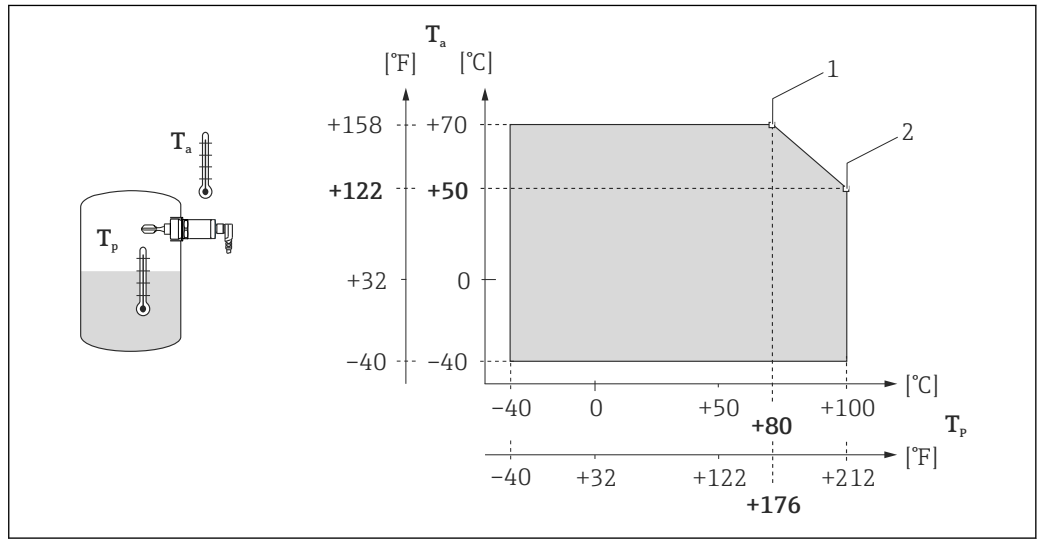

A0022002

5 Derating curve: 100 °C (212 °F)

1 I_{max} : 200 mA (DC-PNP), 250 mA (AC/DC)

2 I_{max} : 150 mA (DC-PNP), 150 mA (AC/DC)

Ta Ambient temperature range

Tp Process temperature

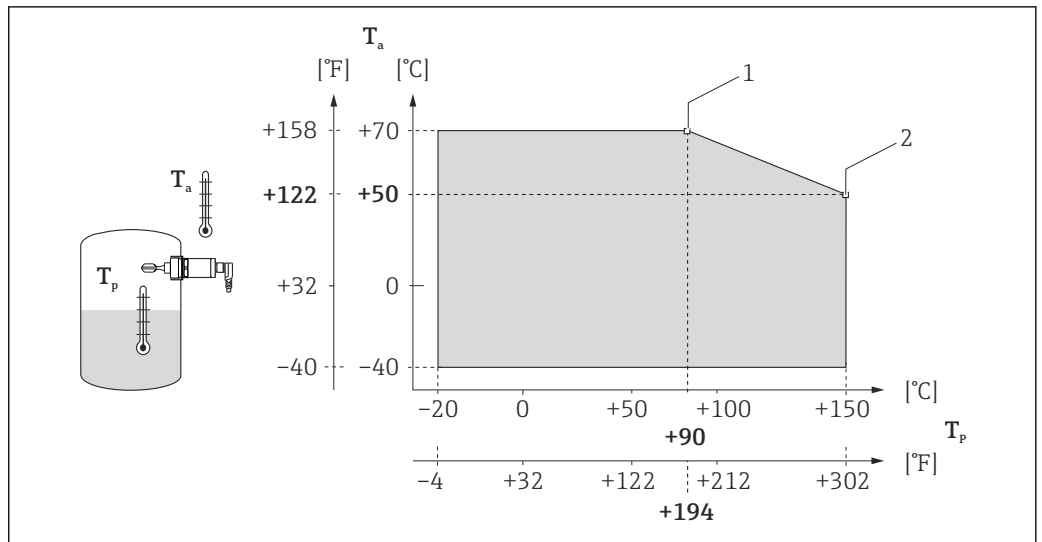

A0020869

6 Derating curve: 150 °C (302 °F)

1 I_{max} : 200 mA (DC-PNP), 250 mA (AC/DC)

2 I_{max} : 150 mA (DC-PNP), 150 mA (AC/DC)

Ta Ambient temperature range

Tp Process temperature

Storage temperature -40 to +85 °C (-40 to +185 °F)

Climate class DIN EN 60068-2-38/IEC 68-2-38: test Z/AD

Altitude Up to 2 000 m (6 600 ft) above sea level

Degree of protection	<ul style="list-style-type: none"> ▪ IP65/67 NEMA Type 4X Enclosure (M12 connector) ▪ IP66/68/69K NEMA Type 4X/6P Enclosure (M12 connector for metal housing cover) ▪ IP65 NEMA Type 4X Enclosure (valve plug) ▪ IP66/68 NEMA Type 4X/6P Enclosure (cable)
Shock resistance	a = 300 m/s ² = 30 g, 3 planes x 2 directions x 3 shocks x 18 ms, as per test Ea, prEN 60068-2-27:2007
Vibration resistance	a(RMS) = 50 m/s ² , ASD = 1.25 (m/s ²) ² /Hz, f = 5 to 2000 Hz, t = 3 x 2 h, as per test Fh, EN 60068-2-64:2008
Cleaning	Resistant to typical cleaning agents from the outside. Passed Ecolab test.
Electromagnetic compatibility	<p>Electromagnetic compatibility in accordance with all relevant requirements of the EN 61326 series and NAMUR recommendation EMC (NE21). For details, refer to the EC Declaration of Conformity. The EC Declaration of Conformity is available in the Download Area of the Endress+Hauser website: www.endress.com:</p> <ul style="list-style-type: none"> ▪ Select your country from the menu bar ▪ In the menu bar, click Download ▪ Enter product root FTL33 ▪ In the search area, select approvals and certificates ▪ Click "Start search" and select the desired document
Reverse polarity protection	<p>2-wire AC/DC</p> <ul style="list-style-type: none"> ▪ AC mode: the device has reverse polarity protection. ▪ DC mode: in the event of reverse polarity the maximum safety mode is always detected. Check the wiring and perform a function check before commissioning. The device is not damaged in the event of reverse polarity. <p>3-wire DC-PNP</p> <p>Integrated. In the event of reverse polarity, the device is deactivated automatically.</p>
Short-circuit protection	<p>2-wire AC/DC</p> <p>During switching the sensor checks whether a load, e.g. relay or contactor, is present (load check). If an error occurs, the sensor is not damaged. Smart monitoring: normal operation is resumed once the error is fixed.</p> <p>3-wire DC-PNP</p> <p>Overload protection/short-circuit protection at I > 250 mA; the sensor is not destroyed. Smart monitoring: check for overload in intervals of approx. 1.5 s; normal operation is resumed once the overload/short-circuit is fixed.</p>

Process



Pay attention to the pressure and temperature derating depending on the selected process connection (→ 20).

Process temperature range	-40 to +100 °C (-40 to +212 °F) -40 to +150 °C (-40 to +302 °F)
Process pressure range	Max. -1 to +40 bar (-14.5 to +580 psi)
Density	> 0.7 g/cm ³ (optionally available: > 0.5 g/cm ³)
State of aggregation	Liquid
Viscosity	1 to 10 000 mPa·s, dynamic viscosity
Solids contents	ø < 5 mm (0.2 in)
Lateral loading capacity	Lateral loading capacity of the tuning fork: maximum 200 N

Mechanical construction

Design

Various versions of the point level switch are available, the features of which can be selected to suit your user needs.

The versions can be selected via the product structure in the Product Configurator, see the "Ordering information" section (→ [29](#)). Examples can be seen in the following diagram:

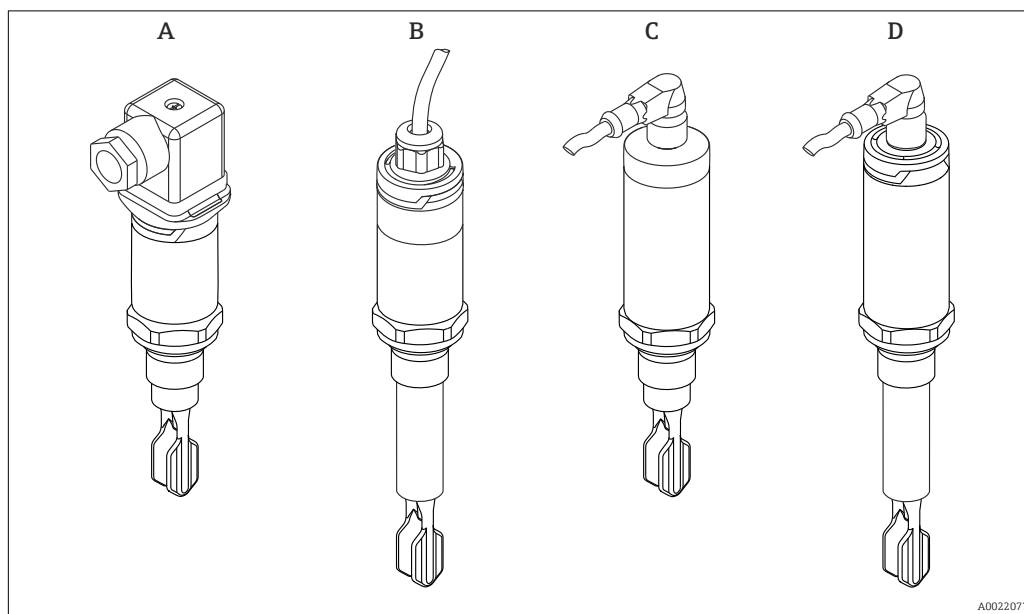

Versions	Examples			
	A	B	C	D
Electrical connection	Valve plug	Cable (cannot be dismantled)	M12 connector for housing cover IP66/68/69K	M12 connector for housing cover IP65/67
Housing (sensor design) for process temperatures up to:	100 °C (212 °F)	100 °C (212 °F)	150 °C (302 °F)	150 °C (302 °F)
Sensor type	Compact version	Short tube version	Compact version	Short tube version

i Detailed information on the process connections is provided in the "Sensor type" section (→ [20](#))

i Information on the short tube version is provided in the "Installation instructions" section (→ [13](#)).

Connector

Dimensions

Dimensions mm (in)

The following graphics illustrate the connectors together with the suitable housing covers on the housing of the point level switch.

Electrical connection with housing cover		Designation
<p>A</p> <p>A0021859</p>	<p>B</p> <p>A0021860</p>	<p>A: Valve plug M16, NPT ½" for housing cover: PPSU plastic</p> <p>B: Valve plug QUICKON for housing cover: PPSU plastic</p>
<p>A</p> <p>A0021858</p>	<p>B</p> <p>A0021857</p>	<p>A: M12 connector for housing cover: 316L (1.4404), IP66/68/69K</p> <p>B: M12 connector for housing cover: PPSU plastic (IP65/67)</p>
<p>A0021692</p>		<p>Captive cable with housing cover: PPSU plastic</p>

Tuning fork

Dimensions

Dimensions mm (in)

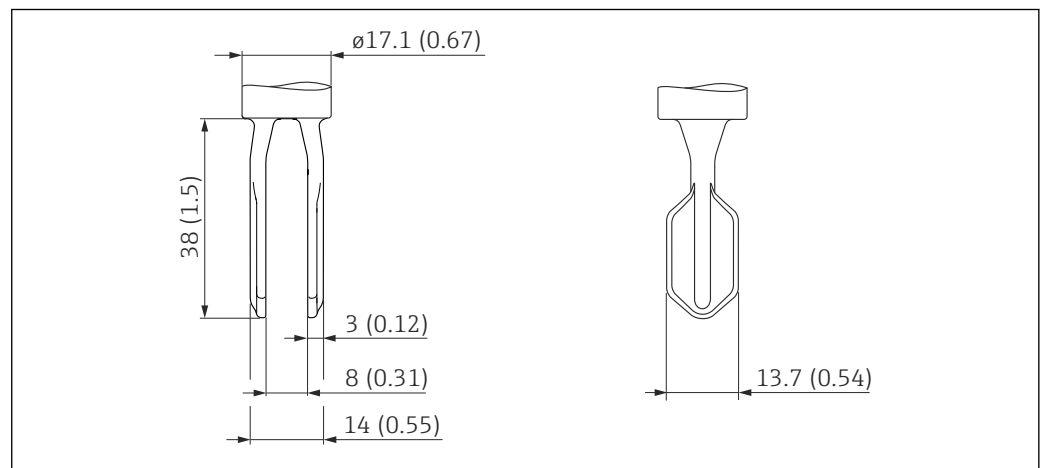

Sensor type

Dimensions

Dimensions mm (in)

The total dimensions of the device can vary depending on the connector selected. To determine the total dimensions, please refer also to the "Electrical connection" section (→ 19).

Information on the following tables

- Meaning of symbols:
 - * Dimension for process temperature max. 100 °C (212 °F)
 - ** Dimension for process temperature max. 150 °C (302 °F)
- If several versions have the same dimensions, one example of the compact version and one example of the short tube version is given.
- The versions in the second column refer to the process connections in the product structure.

 Information on 3-A and EHEDG-approved weld-in adapters can be found in the "Weld-in adapter and flanges" documentation, TI00426F/00/EN.(→ 33).

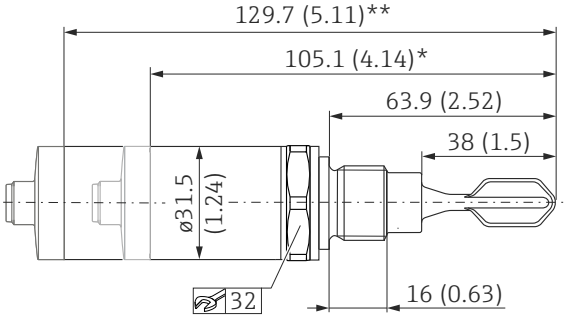
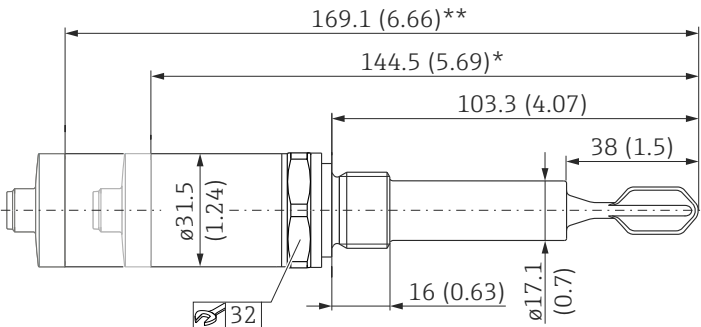
Dimensions	Version	Description
 <p>7 Compact version, example G ½"</p> <p style="text-align: right; font-size: small;">A0021787</p>	<p>WBJ</p> <p>W5J</p>	<p>Thread ISO 228 G ½"</p> <ul style="list-style-type: none"> ■ Material: 316L ■ Scope of delivery: flat seal (FA) ■ Pressure and temperature (maximum): +40 bar (+580 psi) at +150 °C (+302 °F) <p>Thread ISO 228 G ¾" for flush-mounted installation in weld-in adapter</p> <ul style="list-style-type: none"> ■ Material: 316L ■ Scope of delivery: flat seal (FA) <p>Accessory: weld-in adapter</p> <ul style="list-style-type: none"> - Scope of delivery: seal (VMQ) - Pressure and temperature (maximum): +25 bar (+362 psi) at +150 °C (+302 °F) +40 bar (+580 psi) at +100 °C (+212 °F) - Approval: EHEDG (Ra 1.5 µm (59 µin), 0.76 µm (30 µin)) 3-A (Ra 0.76 µm (30 µin))
 <p>8 Short tube version, example G ½"</p> <p style="text-align: right; font-size: small;">A0021883</p>		

Dimensions	Version	Description
<p> 9 Compact version 10 Short tube version </p>	<p>WSJ</p>	<p>Thread ISO 228 G 1" for flush-mounted installation in weld-in adapter</p> <ul style="list-style-type: none"> Material: 316L Scope of delivery: flat seal (FA) <p>Accessory: weld-in adapter</p> <ul style="list-style-type: none"> Scope of delivery: seal (VMQ) Pressure and temperature (maximum): +25 bar (+362 psi) at +150 °C (+302 °F) +40 bar (+580 psi) at +100 °C (+212 °F) Approval: EHEDG (Ra 1.5 µm (59 µin), 0.76 µm (30 µin)) 3-A (Ra 0.76 µm (30 µin))

Dimensions	Version	Description
<p> 11 Compact version, example MNPT 1/2" 12 Short tube version, example MNPT 1/2" </p>	<p>VAJ VBJ</p>	<p>Thread ASME MNPT 1/2"</p> <p>Thread ASME MNPT 3/4"</p> <ul style="list-style-type: none"> Material: 316L Pressure and temperature (maximum): +40 bar (+580 psi) at +150 °C (+302 °F) <p>The dimensions apply for MNPT 1/2" and MNPT 3/4".</p>

Dimensions	Version	Description
<p>144.5 (5.69)** 129.7 (5.11)* 66.4 (2.61) 47.9 (1.89) 38 (1.5) 31.5 (1.24) 32</p> <p>A0022330</p> <p>13 Compact version</p>	VCJ	Thread ASME MNPT 1" <ul style="list-style-type: none"> Material: 316L Pressure and temperature (maximum): +40 bar (+580 psi) at +150 °C (+302 °F)
<p>183.6 (7.23)** 159 (6.26)* 116.8 (4.57) 98.3 (3.87) 38 (1.5) 31.5 (1.24) 17.1 (0.7) 32</p> <p>A0022331</p> <p>14 Short tube version</p>		

Dimensions	Version	Description
<p>129.7 (5.11)** 105.1 (4.14)* 64.9 (2.56) 38 (1.5) 31.5 (1.24) 32</p> <p>A0021870</p> <p>15 Compact version</p>	X2J	Thread M24x1.5 for flush-mounted installation in adapter <ul style="list-style-type: none"> Material: 316L Scope of delivery: O-ring (EPDM) <p>Accessories: process adapter - Scope of delivery: O-ring (EPDM) - Temperature (maximum): 130 °C (266 °F), for information on the pressure ratings, see the "Accessories" section (→ 30)</p> <p>Accessory: weld-in adapter - Scope of delivery: O-ring (EPDM) - Pressure and temperature (maximum): +25 bar (+362 psi) at +150 °C (+302 °F) - Approval: EHEDG (Ra 1.5 µm (59 µin), 0.76 µm (30 µin)) 3-A (Ra 0.76 µm (30 µin))</p>
<p>169.1 (6.66)** 144.5 (5.69)* 104.3 (4.12) 38 (1.5) 31.5 (1.24) 17.1 (0.7) 32</p> <p>A0021894</p> <p>16 Short tube version</p>		

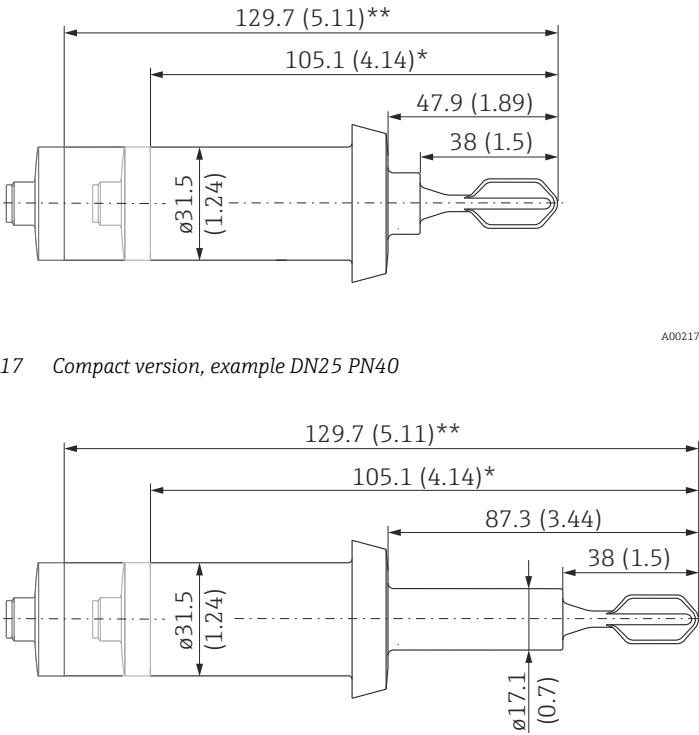
Dimensions	Version	Description
 <p data-bbox="161 616 587 645">17 Compact version, example DN25 PN40</p> <p data-bbox="161 1025 603 1055">18 Short tube version, example DN25 PN40</p>	<p data-bbox="922 253 954 282">1GJ</p> <p data-bbox="922 297 954 327">1HJ</p> <p data-bbox="922 342 954 371">1JJ</p>	<p data-bbox="1023 253 1347 282">DIN11851 DN25 PN40 (dairy pipe)</p> <p data-bbox="1023 297 1347 327">DIN11851 DN32 PN40 (dairy pipe)</p> <p data-bbox="1023 342 1347 371">DIN11851 DN40 PN40 (dairy pipe)</p> <ul data-bbox="1023 387 1500 622" style="list-style-type: none"> Material: 316L Scope of delivery: excluding slotted nut, excluding seal Pressure and temperature (maximum): +25 bar (+362 psi) at +150 °C (+302 °F) +40 bar (+580 psi) at +100 °C (+212 °F) Approval: - EHEDG (Ra 1.5 µm (59 µin), 0.76 µm (30 µin)) - 3-A (Ra 0.76 µm (30 µin)) <p data-bbox="1023 633 1508 712">i Pay attention to the temperature and pressure specifications for the seals and clips used at the customer site.</p> <p data-bbox="1023 723 1468 779">i A slotted nut can be ordered as an optional accessory (→ 31)</p> <p data-bbox="1023 790 1444 819">The dimensions apply for DN25, DN32, DN40.</p>

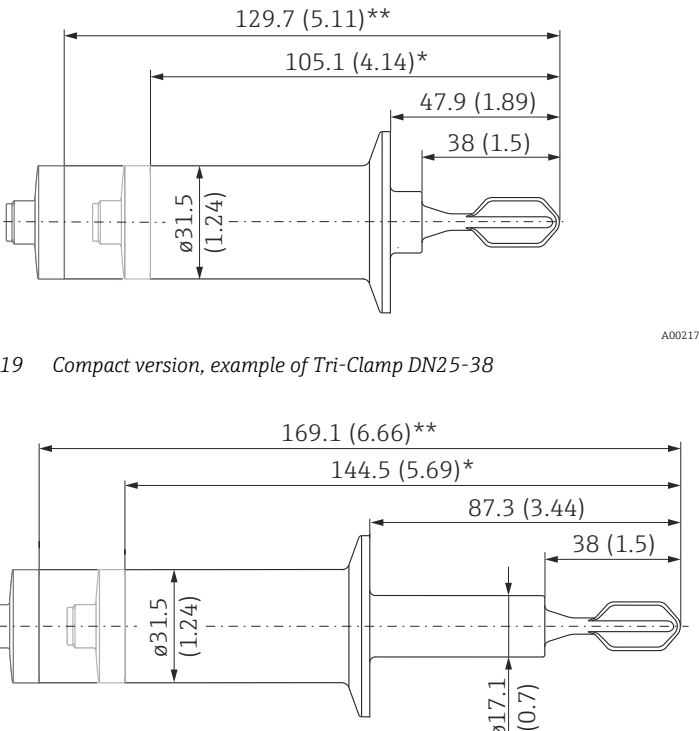
Dimensions	Version	Description
 <p data-bbox="161 1525 683 1554">19 Compact version, example of Tri-Clamp DN25-38</p> <p data-bbox="161 1944 699 1973">20 Short tube version, example of Tri-Clamp DN25-38</p>	<p data-bbox="922 1167 954 1196">3CJ</p> <p data-bbox="922 1234 954 1263">3EJ</p>	<p data-bbox="1023 1167 1410 1223">Tri-Clamp ISO2852 DN25-38 (1 to 1 ½") DIN32676 DN25-40</p> <p data-bbox="1023 1234 1342 1290">Tri-Clamp ISO2852 DN40-51 (2") DIN32676 DN50</p> <ul data-bbox="1023 1301 1500 1536" style="list-style-type: none"> Material: 316L The sealing ring and clip and not included in the delivery and can be purchased from a specialist retailer. Pressure and temperature (maximum): +25 bar (+362 psi) at +150 °C (+302 °F) Approval: - EHEDG (Ra 1.5 µm (59 µin), 0.76 µm (30 µin)) - 3-A (Ra 0.76 µm (30 µin)) <p data-bbox="1023 1547 1508 1626">i Pay attention to the temperature and pressure specifications for the seals and clips used at the customer site.</p> <p data-bbox="1023 1637 1444 1693">The dimensions apply for Tri-Clamp DN25-38, DN40-51.</p>

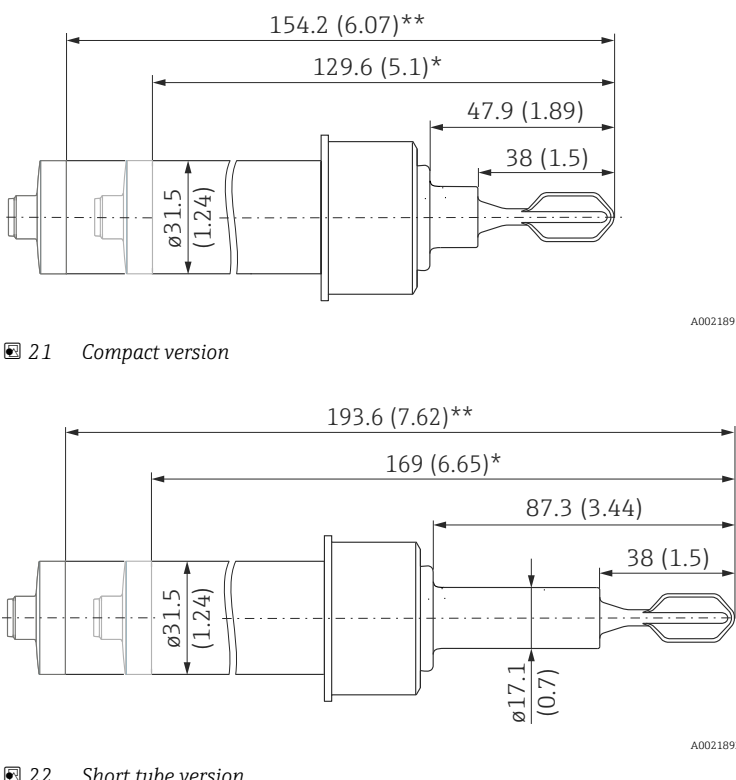
Dimensions	Version	Description
 <p>21 Compact version</p> <p>22 Short tube version</p>	5ZJ	<p>Flush-mounting in weld-in adapter RD52, tuning fork can be aligned</p> <ul style="list-style-type: none"> Material: 316L Scope of delivery: excluding slotted nut, excluding seal <p>Accessory: weld-in adapter</p> <ul style="list-style-type: none"> Scope of delivery: seal (VMQ) Pressure and temperature (maximum): <ul style="list-style-type: none"> +25 bar (+362 psi) at +150 °C (+302 °F) +40 bar (+580 psi) at +100 °C (+212 °F) <p>Approval:</p> <ul style="list-style-type: none"> EHDG (Ra 1.5 µm (59 µin), 0.76 µm (30 µin)) 3-A (Ra 0.76 µm (30 µin)) <p>i A slotted nut can be ordered as an optional accessory (→ 31)</p>

i Pay attention to the temperature and pressure specifications for seals and clips used at the customer site.

i Endress+Hauser supplies DIN/EN process connections with threaded connection in stainless steel in accordance with AISI 316L (DIN/EN material number 1.4404 or 1.4435). With regard to their stability-temperature property, the materials 1.4404 and 1.4435 are grouped together under 13E0 in EN 1092-1, Tab. 18. The chemical composition of the two materials can be identical.

Weight	Sensor type	Weight
	Compact version with process adapter G ½" and valve plug for process temperature up to 100 °C (212 °F)	Approx. 140 g (4.938 oz)
	Short tube version with process adapter G ½" and valve plug for process temperature up to 150 °C (302 °F)	Approx. 169 g (5.961 oz)

Materials

Material specifications in accordance with AISI and DIN EN.

Materials in contact with process

Component part	Material
Tuning fork	316L
Process adapter	316L (1.4404/1.4435)
Short tube	316L (1.4404/1.4435)
Seal for weld-in adapter with G ¾", G 1"	VMQ
Seal for process adapter with M24 thread	EPDM
Flat seal	FA (composite material based on aramid fibers combined with NBR)

Materials not in contact with process

Component part	Material
Housing cover with M12 connector (IP66/68/69K)	316L (1.4404/1.4435)
Housing cover with M12 connector (IP65/67)	PPSU
Housing cover with valve plug (IP65)	
Housing cover with cable (IP66/68)	
Cable gland	PVDF
Design ring	PBT/PC
Housing	316L (1.4404/1.4435)
Nameplate	lasered onto housing

Surface roughness

Metallic surface in contact with process:

$R_a \leq 1.5 \mu\text{m}$ (59 μin), EHEDG

$R_a \leq 0.76 \mu\text{m}$ (30 μin), EHEDG, 3-A



The surface is not defined in the area of the welding seam.

Operability

LED display

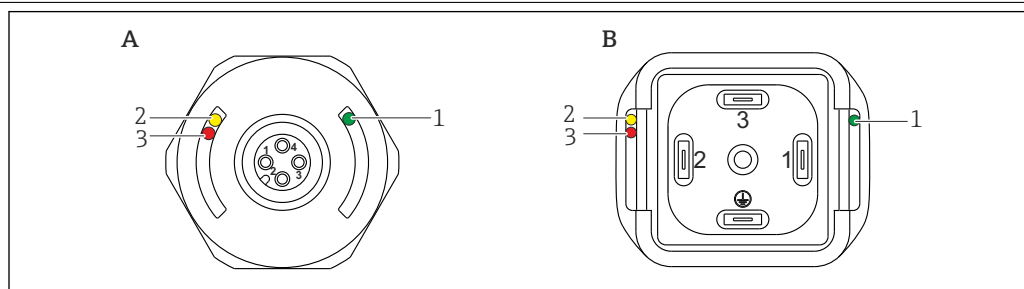

A0016856

- A M12 connector, (cable without graphic)
B Valve plug

Item	Function	Description
1	Green LED (gn) Lit	Device is operational
2	Yellow LED (ye) Lit	M12 connector Indicates the sensor state: tuning fork is covered by liquid Valve plug / cable Indicates the switching state: <ul style="list-style-type: none"> ▪ MAX operating mode (overflow prevention): sensor is not covered by liquid ▪ MIN operating mode (dry running protection): the sensor is covered by liquid
3	Red LED (rd) flashing Lit	Warning/maintenance required: error can be rectified, e.g. incorrect wiring Fault/device failure: error cannot be rectified, e.g. electronic error

i For the metallic housing cover (IP69K), there is no external signaling via LEDs. A connecting cable with an M12 connector and LED display can be ordered as an accessory (→ 31).

Function test with test magnet

To perform a function test, hold the test magnet against the marking on the nameplate (for at least 2 seconds). This inverts the current switching status and the yellow LED changes state. When the magnet is removed, the switching status valid at that time is adopted.

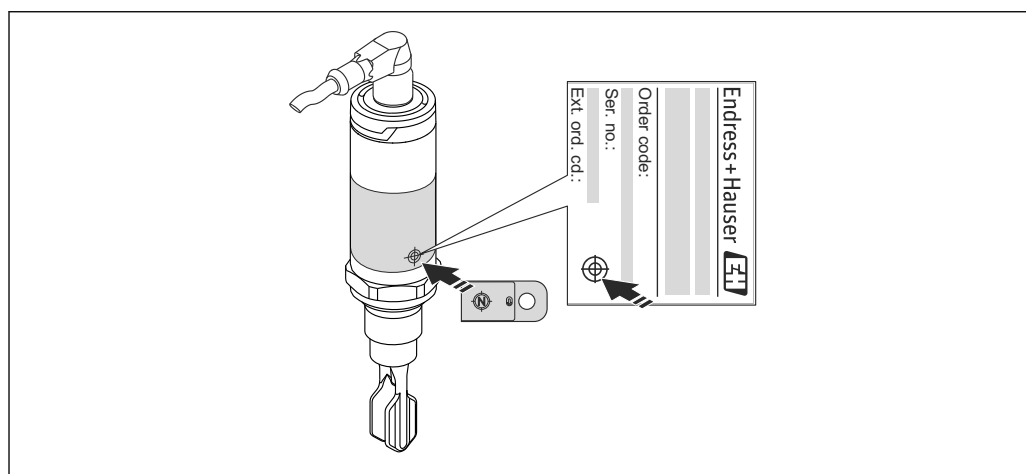

A0020960

23 Test magnet and marking

i The test magnet is not included in the delivery and can be ordered as an optional accessory (→ 32).

Certificates and approvals

 The following documents are also available in the Download Area of the Endress+Hauser website: www.endress.com → [Download](#)

CE mark	The measuring system is in conformity with the statutory requirements of the applicable EC Directives. These are listed in the corresponding EC Declaration of Conformity along with the standards applied. Endress+Hauser confirms successful testing of the device by affixing to it the CE mark.
C-Tick symbol	The measuring system complies with EMC requirements of the "Australian Communications and Media Authority (ACMA)".
Approval	CSA C/US General Purpose
Hygienic compatibility	The Liquiphant FTL33 was developed for use in hygienic processes. The wetted materials meet the requirements of FDA and 3-A-Sanitary Standard No. 74-06. Endress+Hauser confirms this by affixing the 3-A sign to the device.

The following certificate copies can be ordered with the device (optional):

3-A



EHEDG



- If cleaning in place (CIP) is required, weld-in adapters that comply with 3-A requirements are offered. If installed horizontally, ensure that the leakage hole is pointing down. This allows leaks to be detected as quickly as possible.
- To avoid the risk of contamination, install the device in accordance with the design principles of EHEDG, Document 37 "Hygienic Design and Application for Sensors" and Document 16 "Hygienic Pipe Connections".
- Suitable connections and seals must be used in order to guarantee hygiene-compliant design as per 3-A and EHEDG specifications.
- Information on 3-A and EHEDG-approved weld-in adapters can be found in the "Weld-in adapter and flanges" documentation, TI00426F/00/EN.
- The gap-free connections can be cleaned of all residue using sterilization in place (SIP) and cleaning in place (CIP), which are typical cleaning methods within the industry. Attention must be paid to the pressure and temperature specifications of the sensor and process connections for CIP and SIP processes.

Hygiene approval

Information on 3-A and EHEDG-approved weld-in adapters can be found in the "Weld-in adapter and flanges" documentation, TI00426F/00/EN.

The versions can be selected via the product structure in the Product Configurator, see also (→  29).

Process connections	Approvals		
	Version	EHEDG	3-A
Thread ISO228 G ½", 316L	WBJ	-	-
Thread ISO228 G 1, 316L, weld-in adapter installation accessory Thread ISO228 G ¾", 316L, weld-in adapter installation accessory	WSJ W5J	x	x
Thread M24, 316L, installation, adapter accessory	X2J	x	x
Thread ASME MNPT ½", 316L Thread ASME MNPT ¾", 316L Thread ASME MNPT 1", 316L	VAJ VBJ VCJ	-	-
DIN11851 DN25 PN40 without slotted nut, 316L DIN11851 DN32 PN40 without slotted nut, 316L DIN11851 DN40 PN40 without slotted nut, 316L	1GJ 1HJ 1JJ	x	x
Tri-Clamp ISO2852 DN25-38 (1 to 1-½"), 316L, DIN32676 DN25-40 Tri-Clamp ISO2852 DN40-51 (2"), 316L, DIN32676 DN50	3CJ 3EJ	x	x
Flush-mounted, 316L, without slotted nut, weld-in adapter installation accessory	5ZJ	x	x

Overfill prevention

 Prior to mounting the device, pay attention to the WHG approval documents. The documents can be found in the Download Area of the Endress+Hauser website.

WHG

- Overfill detection system: Z-65.11-531
- Leak detection system: Z-65.40-532

CRN approval

Versions with a CRN approval (Canadian Registration Number) are listed in the corresponding registration documents. CRN-approved devices are labeled with registration number OF16950.5.

Inspection certificates

The following documents can be ordered with the device (optional):

- Acceptance test certificate as per EN 10204-3.1 (only for versions with ≤ RA 0.76 µm (30 µin))
- Surface roughness test report as per ISO4287/Ra (only for versions with ≤ RA 0.76 µm (30 µin))
- Final inspection report

Manufacturer declarations

The following documents can be ordered with the device (optional):

- FDA conformity
- TSE-free, materials free from animal origin
- ROHS-compliant in accordance with Endress+Hauser regulation
- Regulation EC 2023/ 2006 (GMP)
- Regulation (EC) No. 1935/2004 on materials intended to come into contact with food

Pressure Equipment Directive

The Liquiphant FTL33 does not fall within the scope of Pressure Equipment Directive 97/23/EC as it does not have a pressurized housing as defined in Article 1, Section 2.1.4 of the directive.

Other standards and guidelines

The applicable European guidelines and standards can be found in the relevant EU Declarations of Conformity.

Regulation (EU) No. 10/2011: The Liquiphant FTL33 does not fall within the scope of the regulation on plastic materials and articles intended to come into contact with food as the wetted materials are made of stainless steel only and the seals supplied in the standard version are made from silicone. Silicones do not fall within the scope of the regulation.

Ordering information

Product Configurator



Product Configurator - the tool for individual product configuration

Detailed ordering information is available from the following sources:

- In the Product Configurator on the Endress+Hauser website: www.endress.com → Select country → Products → Select product → Enter product root → Product page function: Configure this product
- From your Endress+Hauser Sales Center: www.endress.com/worldwide
- Up-to-the-minute configuration data
- Depending on the device: Direct input of information specific to measuring point, such as measuring range or operating language
- Automatic verification of exclusion criteria
- Automatic creation of the order code and its breakdown in PDF or Excel output format
- Ability to order directly in the Endress+Hauser Online Shop

Services (optional)

In addition, the following services can be selected via the product structure in the Product Configurator:

- Cleaned of oil+grease
- Density setting > 0.5 g/cm³
- Switching delay setting (→ 11)

Accessories

 The adapters are optionally available with inspection certificate 3.1 EN10204.

Process adapter M24

The following process adapters are available for process connection M24. Please pay attention to the material specifications (→  24)

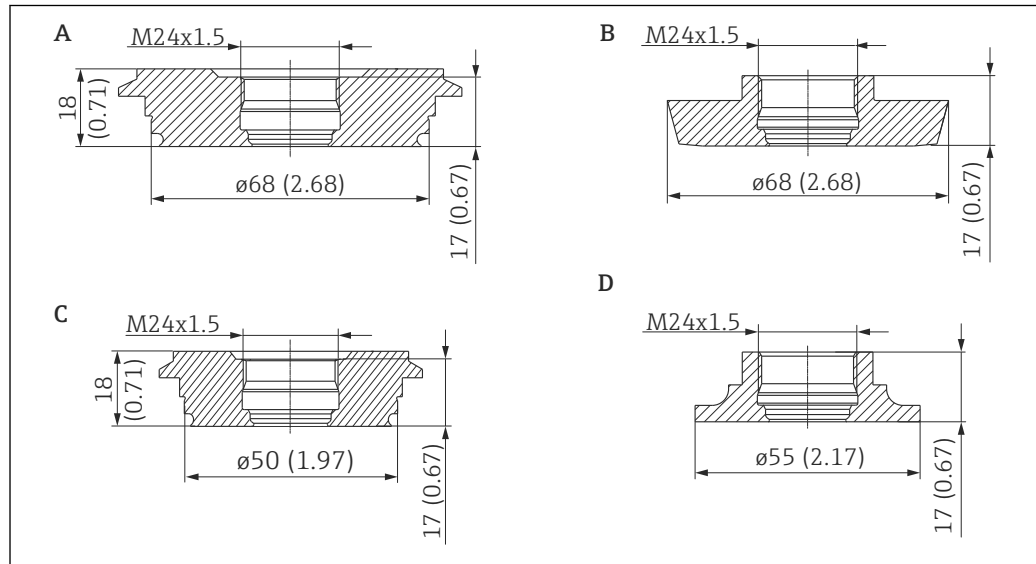

A0016863

View	Process adapter M24 for:	Pressure rating PN	Order number	Order number with 3.1 inspection certificate
A	Varivent N	40	52023997	52024004
B	DIN11851 DN50 with slotted nut	25	52023998	52024005
C	Varivent F	40	52023996	52024003
D	SMS 1½"	25	52026997	52026999

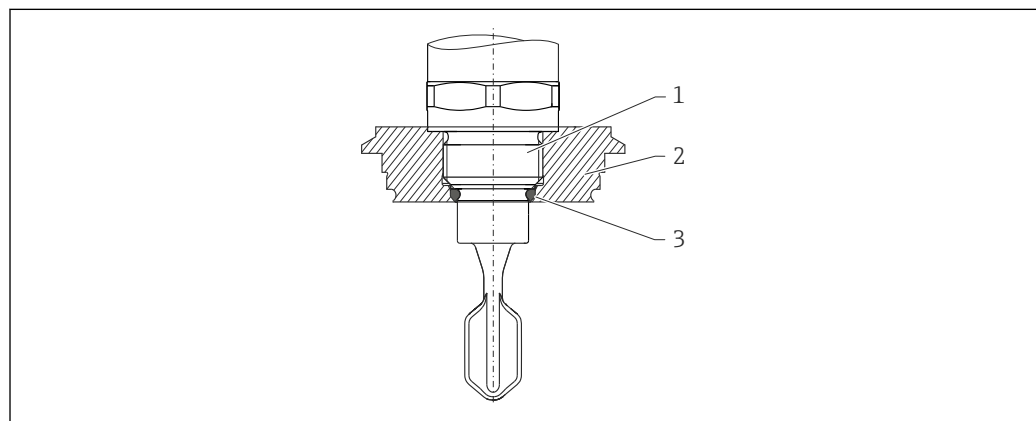

A0022261



- 1 Device with process adapter M24
- 2 Hygienic connection (Varivent example)
- 3 O-ring

Weld-in adapter

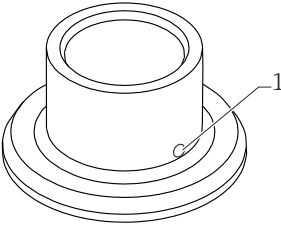
Various weld-in adapters are available for installation in vessels or pipes.

View (example)	Description
 <p>1 Leakage hole</p> <p>A0023557</p>	G 3/4" ø29 pipe installation ø50 vessel installation FDA-listed materials as per 21 CFR Part 175-178
	G 1" ø53 pipe installation ø60 vessel installation
	M24 ø65 vessel installation
	Rd52 Vessel installation

If installed horizontally and weld-in adapters with a leakage hole are used, ensure that the leakage hole is pointing down. This allows leaks to be detected as quickly as possible.

 Detailed information can be found in TI00426F/00/EN "Weld-in adapter and flanges" and in the supplementary documentation (→  33).

Slotted nut

The slotted nuts can be ordered optionally as an accessory.

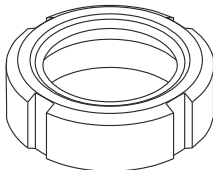
View (example)	Process adapter DIN11851 (dairy pipe)	PN	Order number
 <p>A0023556</p>	DIN11851 F25 (also for process adapter, flush- mounted)	40	52021715
	DIN11851 F32	40	71258359
	DIN11851 F40	40	71258361
	Material: 304 (1.4307)		

Plug-in jack, cable

 The plug-in jacks listed are suitable for use in the temperature range -25 to +70 °C (-13 to +158 °F).

Engineering unit mm (in)

Plug-in jack M12 IP69K with LED	Description	Order number
<p>A0020871</p>	<ul style="list-style-type: none"> elbowed 90° terminated at one end 5 m (16 ft) cable PVC (orange) Slotted nut 316L Body: PVC (transparent) 	52018763

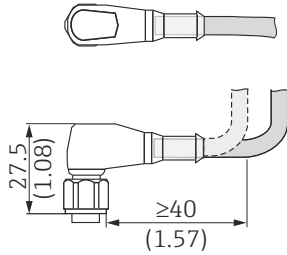
Plug-in jack M12 IP69K	Description	Order number
 <p style="text-align: right; font-size: small;">A0023713</p>	<ul style="list-style-type: none"> ■ terminated at one end ■ elbowed 90° ■ 5 m (16 ft) cable PVC (orange) ■ Slotted nut 316L (1.4435) ■ Body: PVC (orange) 	52024216

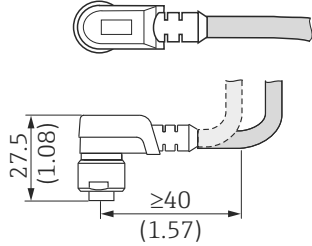
Plug-in jack M12 IP67	Description	Order number
 <p style="text-align: right; font-size: small;">A0022292</p>	<ul style="list-style-type: none"> ■ elbowed 90° ■ 5 m (16 ft) cable PVC (gray) ■ Slotted nut Cu Sn/Ni ■ Body: PUR (blue) 	52010285

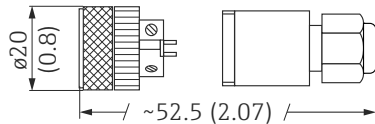
Plug-in jack M12 IP67	Description	Order number
 <p style="text-align: right; font-size: small;">A0022293</p>	<ul style="list-style-type: none"> ■ Self-terminated connection to M12 connector ■ Slotted nut Cu Sn/Ni ■ Body: PBT 	52006263

Wire colors for M12 connector: 1 = BN (brown), 2 = WT (white), 3 = BU (blue), 4 = BK (black)

Additional accessories

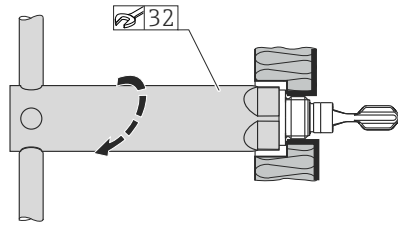
Socket wrench for mounting	Description	Order number
 <p style="text-align: right; font-size: small;">A0022273</p>	<ul style="list-style-type: none"> ■ Hexagonal ■ Size across flats AF32 	52010156

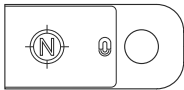
Test magnet	Description	Order number
 <p style="text-align: right; font-size: small;">A0021732</p>	Information is available on (→ 26)	71267011

Supplementary documentation



The following document types are also available in the Download Area of the Endress+Hauser website: www.endress.com → [download](#)

Operating Instructions

Liquiphant FTL33 → BA01286F/00/EN

Additional documentation

TI00426F/00/EN → weld-in adapter (overview)

BA00361F/00/A6 → weld-in adapter M24 (installation instructions)

SD00352F/00/A6 → weld-in adapter G 1", G ¾" (installation instructions)

SD00356F/00/EN → valve plug (installation instructions)

Certificates

ZE01010F/00/EN → overfill prevention

ZE01011F/00/EN → leaks





71267732

www.addresses.endress.com
