

# Technical Information

## Liquistation CSF48

Automatic stationary sampler for liquid media; integrated controller with up to four measuring channels and optional digital Memosens technology



### Application

Liquistation CSF48 is a stationary sampler designed for the fully automated removal, defined distribution, and temperature-controlled storage of liquid media. The standard product version has two 0/4 to 20 mA analog inputs, two binary inputs and two binary outputs. Thanks to the modular platform concept, the CSF48 can be quickly and easily modified to create a measuring station.

- Communal and industrial wastewater treatment plants
- Laboratories and water management offices
- Monitoring of liquid media in industrial processes

### Your benefits

- Four different kinds of housing material
- Two-door housing for reliable sample temperature regulation
- Air circulation in sample chamber with inner lining
- Swift menu guidance, navigator and large display
- Dual bottle trays for easy sample transportation
- Practice-oriented programs ranging from simple time programs to event programs
- Functionality can be extended by installing modular electronic components
- Integrated data logger for recording measured values
- Service interface for data transmission
- Optional battery backup system ensures uninterrupted operation in the event of power failure

## Table of contents

<b>Function and system design</b> . . . . .	<b>4</b>	<b>Relay outputs</b> . . . . .	<b>26</b>
Sampler Liquistation CSF48 . . . . .	4	Electrical specification . . . . .	26
Sampler Liquistation CSF48 with sampling assembly		<b>Protocol-specific data</b> . . . . .	<b>27</b>
Samplefit CSA420 . . . . .	4	HART . . . . .	27
Sampler with online measurement . . . . .	6	PROFIBUS DP . . . . .	27
Mode of operation with a vacuum pump . . . . .	7	Modbus RS485 . . . . .	27
Mode of operation with a peristaltic pump . . . . .	9	Modbus TCP . . . . .	27
Mode of operation with a sampling assembly . . . . .	10	Ethernet/IP . . . . .	28
Sampling with a flow assembly . . . . .	11	Web server . . . . .	28
Sample distribution . . . . .	12	<b>Power supply</b> . . . . .	<b>29</b>
Sample preservation . . . . .	12	Electrical connection . . . . .	29
Sampling control . . . . .	15	Supply voltage . . . . .	29
Intake speed with different suction lines . . . . .	16	Cable entries . . . . .	29
Sample temperature regulation (optional) . . . . .	16	Mains fuse . . . . .	29
Sampler housing . . . . .	17	Power consumption . . . . .	29
<b>Equipment architecture</b> . . . . .	<b>18</b>	Power failure . . . . .	29
Slot and port assignment . . . . .	18	<b>Performance characteristics</b> . . . . .	<b>30</b>
<b>Communication and data processing</b> . . . . .	<b>19</b>	Sampling methods . . . . .	30
<b>Dependability</b> . . . . .	<b>20</b>	Dosing volume . . . . .	30
Reliability . . . . .	20	Dosing accuracy . . . . .	30
Maintainability . . . . .	20	Repeatability . . . . .	30
Safety . . . . .	22	Intake speed . . . . .	30
<b>Input</b> . . . . .	<b>22</b>	Suction height . . . . .	30
Types of input . . . . .	22	Hose length . . . . .	30
Measured values . . . . .	22	Sample supply, sampling assembly . . . . .	30
<b>Temperature inputs</b> . . . . .	<b>23</b>	Temperature control . . . . .	30
Measuring range . . . . .	23	<b>Installation</b> . . . . .	<b>31</b>
Type of input . . . . .	23	Installation instructions . . . . .	31
Accuracy . . . . .	23	Mounting conditions . . . . .	31
<b>Binary input, passive</b> . . . . .	<b>23</b>	Installation conditions for sampling assembly Samplefit	
Span . . . . .	23	CSA420 . . . . .	32
Signal characteristics . . . . .	23	<b>Environment</b> . . . . .	<b>33</b>
Accuracy . . . . .	23	Ambient temperature . . . . .	33
<b>Analog input, passive/active</b> . . . . .	<b>23</b>	Storage temperature . . . . .	33
Span . . . . .	23	Degree of protection . . . . .	33
Accuracy . . . . .	23	Electromagnetic compatibility . . . . .	33
<b>Output</b> . . . . .	<b>23</b>	Electrical safety . . . . .	33
Output signal . . . . .	23	Relative humidity . . . . .	33
Communication . . . . .	23	<b>Process</b> . . . . .	<b>34</b>
Output signal . . . . .	23	Process temperature . . . . .	34
<b>Current outputs, active</b> . . . . .	<b>25</b>	Process characteristics . . . . .	34
Span . . . . .	25	Process pressure . . . . .	34
Signal characteristic . . . . .	25	Process connection . . . . .	34
Signal on alarm . . . . .	25	Process connection for sampling assembly Samplefit	
Load . . . . .	25	CSA420 . . . . .	35
Electrical specification . . . . .	25	<b>Mechanical construction</b> . . . . .	<b>36</b>
Cable specification . . . . .	25	Dimensions . . . . .	36
		Weight . . . . .	37
		Materials . . . . .	38

<b>Operability</b> .....	<b>39</b>
Operating concept .....	39
Display .....	39
Local operation .....	39
Remote operation .....	40
Communication .....	41
Software .....	41
<b>Certificates and approvals</b> .....	<b>42</b>
CE mark .....	42
MCERTS .....	42
cCSAus General purpose .....	42
<b>Ordering information</b> .....	<b>43</b>
Product page .....	43
Product Configurator .....	43
Scope of delivery .....	43
<b>Accessories</b> .....	<b>44</b>
Measuring cable .....	47
Sensors .....	47

## Function and system design

### Sampler Liquistation CSF48

Depending on the version, a complete sampling unit for open channels comprises:

- Controller with display, soft keys and navigator
- Vacuum or peristaltic pump for sampling
- PE or glass sample bottles for sample preservation
- Sampling chamber temperature regulator (optional) for safe sample storage
- Suction line with suction head

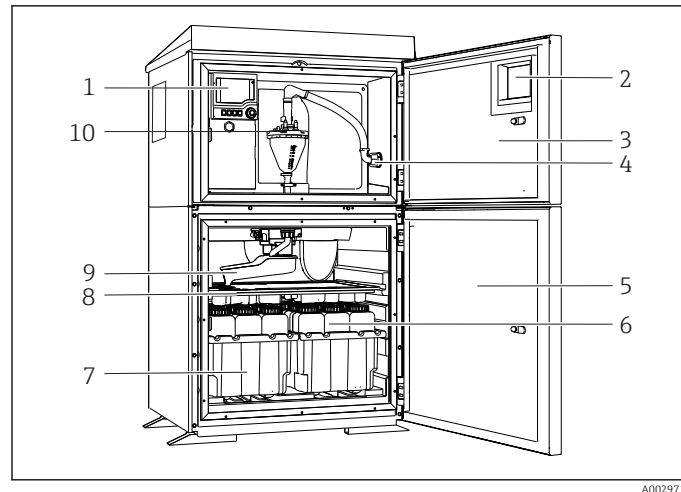

- 1 Controller
- 2 Window (optional)
- 3 Dosing chamber door
- 4 Suction line connection
- 5 Sampling chamber door
- 6 Sample bottles, e.g. 2 x 12 bottles, PE, 1 liter
- 7 Bottle trays (depending on sample bottles selected)
- 8 Distribution plate (depending on sample bottles selected)
- 9 Distribution arm
- 10 Vacuum system, e.g. Dosing system with conductive sample sensor

1 Example of a Liquistation, version with vacuum pump

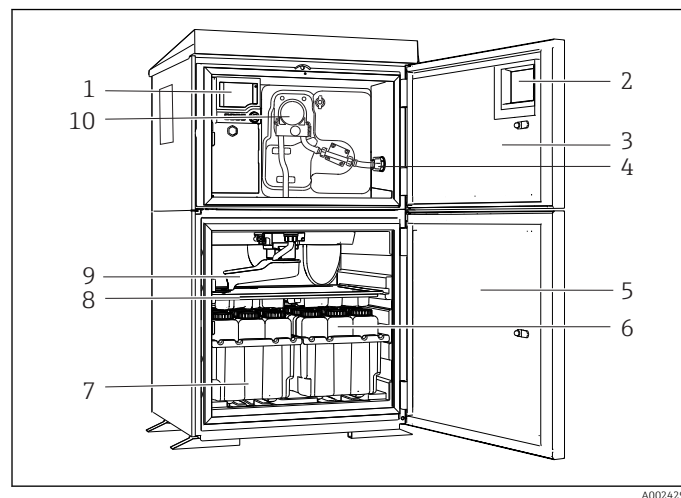

- 1 Controller
- 2 Window (optional)
- 3 Dosing chamber door
- 4 Suction line connection
- 5 Sampling chamber door
- 6 Sample bottles, e.g. 2 x 12 bottles, PE, 1 liter
- 7 Bottle trays (depending on sample bottles selected)
- 8 Distribution plate (depending on sample bottles selected)
- 9 Distribution arm
- 10 Peristaltic pump

2 Example of a Liquistation, version with peristaltic pump

### Sampler Liquistation CSF48 with sampling assembly Samplefit CSA420

A complete sampling unit for pressurized pipes comprises a Liquistation and Samplefit CSA420 sampling assembly with:

- Controller with display, soft keys and navigator
- Samplefit CSA420 sampling assembly for 10 ml, 30 ml or 50 ml sample volume, depending on version
- PE or glass sample bottles for sample preservation
- Sampling chamber temperature regulator (optional) for safe sample storage

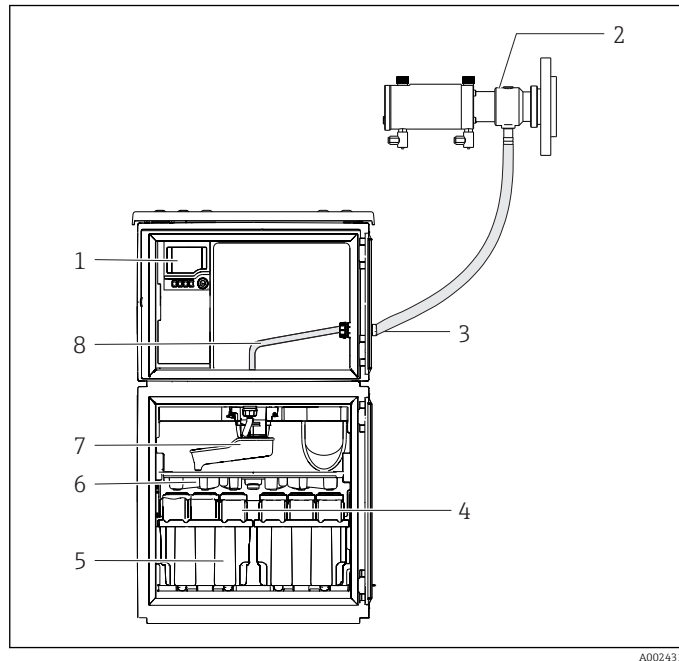

- 1 Controller
- 2 Sampling assembly Samplefit CSA420 (0.5 m (1.6 ft) vertically between assembly and sampler)
- 3 Gland for sample line
- 4 Sample bottles, e.g. 2 x 12 bottles, PE, 1 liter
- 5 Bottle trays (depending on sample bottles selected)
- 6 Distribution plate (depending on sample bottles selected)
- 7 Distribution arm
- 8 Distribution plate (depending on sample bottles selected)
- 9 Distribution arm
- 10 Direct supply line for sample

3 Example of a Liquistation CSF48 with CSA420 sampling assembly  
 Example of Samplefit CSA420 sampling assembly with flange connection

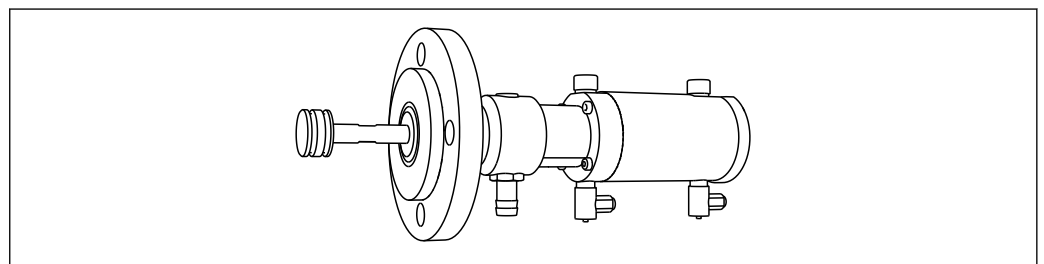

4 Samplefit CSA420 sampling assembly with flange connection DN50, PP

Example of Samplefit CSA420 sampling assembly with Triclamp connection

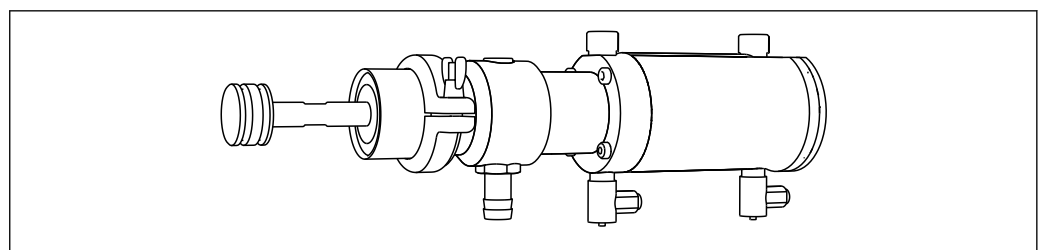

5 Samplefit CSA420 sampling assembly with Triclamp connection DN50, DIN 32676

**Sampler with online measurement**

 The following overview shows examples of the design and layout of a measuring system. Other sensors and assemblies can be ordered for conditions specific to your application. See Accessories section and also --> [www.endress.com/products](http://www.endress.com/products)

**Measuring point**

A complete measuring system with online measurement consists of:

- Liquistation CSF48 sampler
- Sensors with Memosens technology
- Immersion or flow assemblies to suit the sensors used

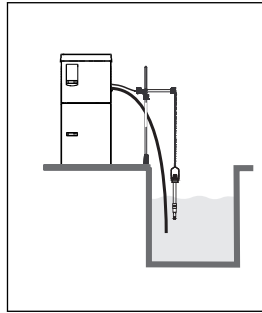

A0029246

**Nitrate**

- Liquistation CSF48 sampler
- Sensors with Memosens technology
- Immersion or flow assemblies to suit the sensors used

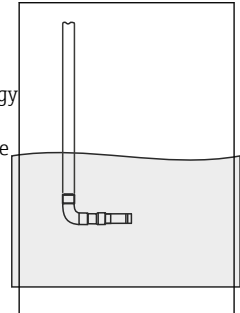

A0024327

**Conductivity**

Inductive conductivity measurement

- Flexdip CYA112 immersion assembly
- Indumax CLS50D sensor with fixed cable

Conductive conductivity measurement

- Flexdip CYA112 immersion assembly
- Condumax CLS15D sensor

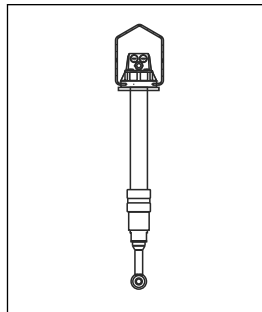

A0024329

**Oxygen**

- Flexdip CYA112 immersion assembly
- Flexdip CYH112 holder
- Sensor
  - Oxymax COS61D (optical) with fixed cable,
  - Oxymax COS51D (amperometric) cable CYK10

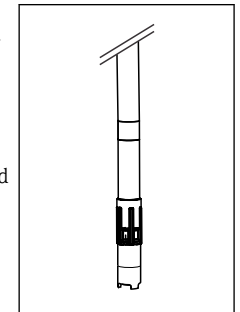

A0024332

Figure: CYA112 with COS61D

**Turbidity**

- Flexdip CYA112 immersion assembly
- Spray head CUR4 (optional)
- Turbimax CUS51D sensor with fixed cable

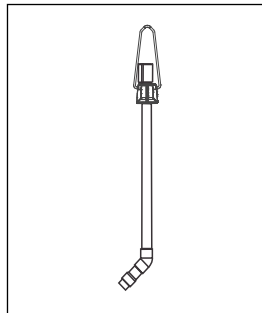

A0024333

**pH value or ORP**

- Retractable assembly Cleanfit CPA471
- Orbisint CPS11D, CPS12D sensor
- Measuring cable CYK10

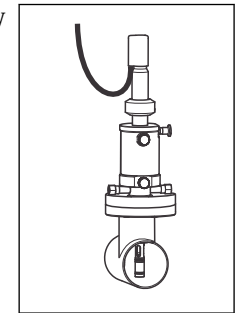

A0024336

- Flowfit CUA250 flow assembly
- Turbimax CUS51D sensor with fixed cable

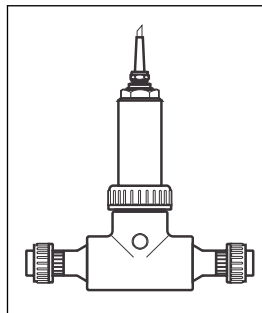

A0024334

- Flexdip CYA112 immersion assembly
- Orbisint CPS12D, CPS11D sensor
- Measuring cable CYK10

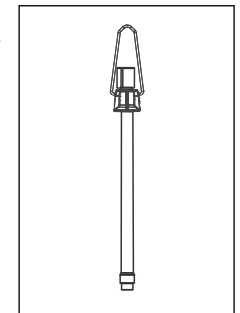

A0024335

### Mode of operation with a vacuum pump

#### Sampling takes place in four steps:

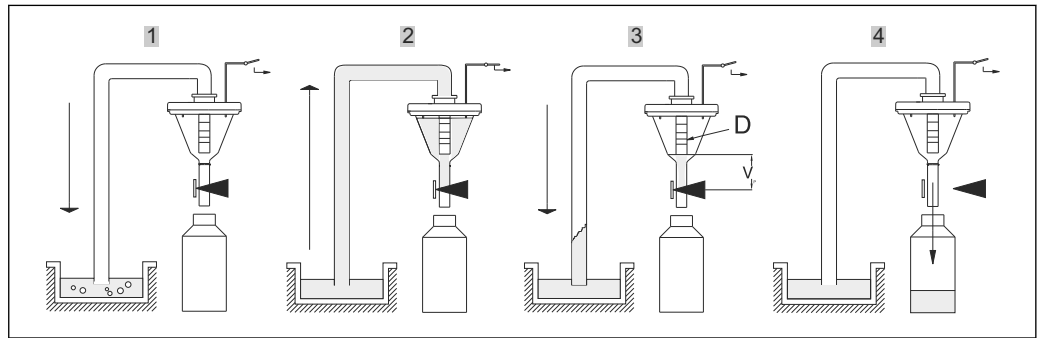

A0022647

1. Blow clear
  - ↳ The vacuum pump blows the suction line clear via the dosing system.
2. Intake
  - ↳ The "Airmanager" (pneumatic control unit) switches the air path of the vacuum pump to "intake". The sample is drawn into the dosing beaker until it reaches the conductivity probes of the dosing system.
3. Dose
  - ↳ The intake process ends. Depending on the position of the dosing tube (item D), the excess sample liquid flows back to the sampling point.
4. Drain
  - ↳ The hose clamp is opened and the sample is drained into the sample bottle.

#### Dosing system with conductive sample sensor

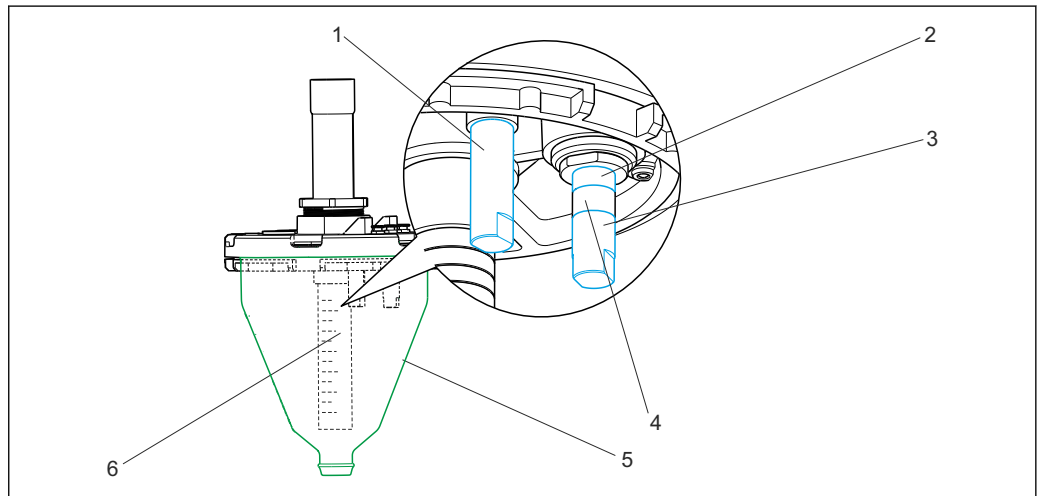

A0022663

#### 6 Conductive dosing system

- 1 Conductivity sensor 1 (common electrode)
- 2 Conductivity sensor 2 (safety electrode)
- 3 Conductivity sensor 3 (standard electrode)
- 4 Insulation
- 5 Measuring jug (plastic version with graduated scale or glass)
- 6 Graduated dosing tube, white and blue scale

#### Sample detection principle

When the sample is drawn in, the sample level reaches conductivity sensors 1 and 3. The system thus detects that the measuring jug is filled and terminates the suction process. If sensor 3 is heavily fouled or fails, conductivity sensor 2 switches to safety mode and turns off the system. This patented sample detection method along with predictive maintenance information prevent vacuum pump failure as a result of flooding.

### Dosing system with capacitance sample sensor

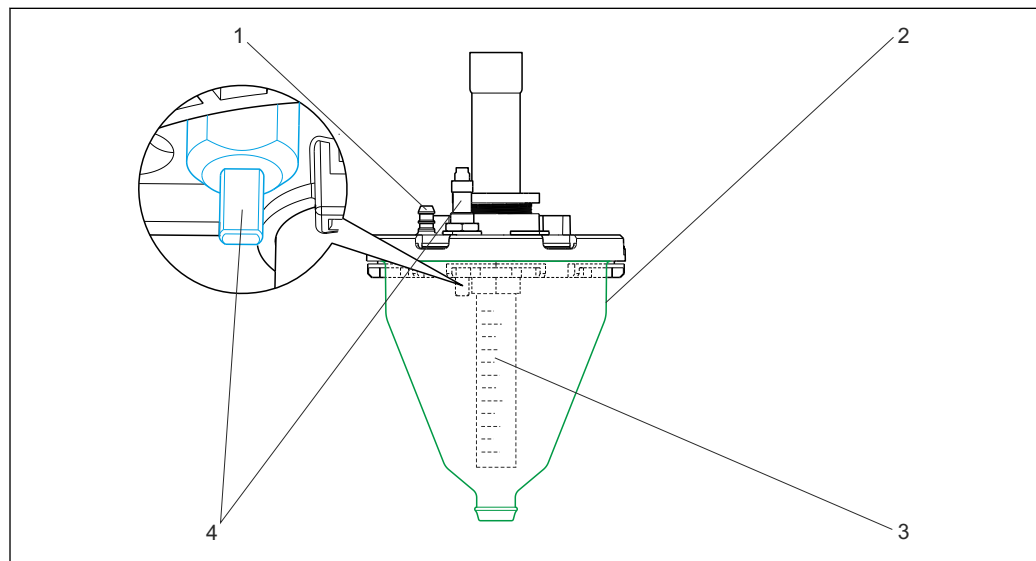

A0024340

#### 7 Capacitance dosing system

- 1 Hose connection for the vacuum pump
- 2 Graduated measuring jug
- 3 Graduated dosing tube, white and blue scale
- 4 Capacitance level sensor

#### Sample detection principle

When the level of medium in the measuring jug changes, the capacitance of a capacitor partly formed by the liquid also changes..

The capacitance sensor ensures rapid sample detection in media that form foam and have a high fat content, and media with a conductivity  $< 30 \mu\text{S}/\text{cm}$ . Only capacitance level detection is possible in the latter type of media.

#### Sample dosing with/without pressure

Sample dosing without pressure is the factory setting for all standard applications in which the sample medium is taken from an open channel or a gravity line. The excess sample can flow back under atmospheric pressure. Sample dosing with pressure is selected for applications in which the sample is taken from a pipe, for example, or for applications involving a low suction height and a low sample volume. In such instances, the sample medium cannot flow back on its own. The maximum pressure in the pipe must be  $< 0.8 \text{ bar}$ . Pressure is applied and the excess sample is forced out of the measuring jug and back to the sampling point. The sample volume is set by adjusting the dosing tube. The white "A" scale applies if dosing without pressure, and the blue "B" scale applies if dosing with pressure.



### Mode of operation with a peristaltic pump

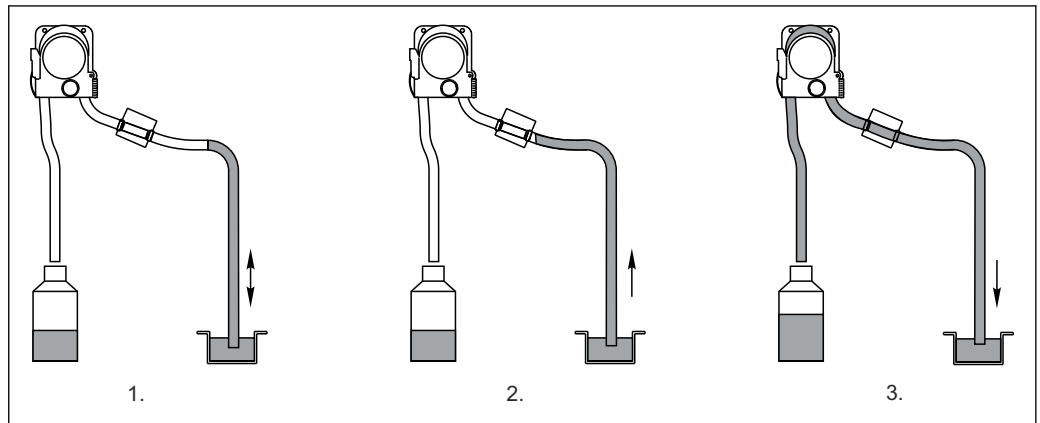

8 Sampling steps with a peristaltic pump

### Sampling takes place in three steps:

1. Rinse
  - ↳ The peristaltic pump runs in reverse and forces medium back to the sampling point.
2. Intake
  - ↳ The peristaltic pump runs forward and draws in medium. If the medium detection system detects the sample, the pump is controlled by the flow and the specified sample volume is calculated automatically.
3. Drain
  - ↳ The pump runs in reverse again and forces the medium back to the sampling point.

One advantage this system offers for obtaining a representative sample is the possibility of rinsing the suction line several times: Medium is initially drawn in until the medium detection system reacts, then the pump switches and forces the medium back to the sampling point. This process can be repeated a maximum of three times. The sample is then taken as described.

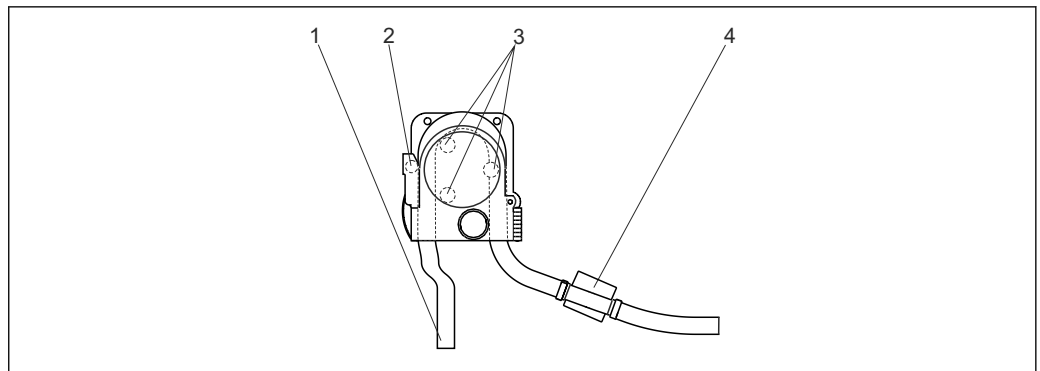

9 Peristaltic pump

- 1 Pump tube
- 2 Safety switch (optional)
- 3 Pump rollers
- 4 Medium detection system (patented)

The pump rollers deform the hose, thereby causing a negative pressure and the suction effect. The medium detection system is based on a pressure sensor which detects the difference between a pipe that is filled and not filled. Thanks to a patented process for automatically detecting the suction height, the user does not have to enter the suction height or suction line length. The self-learning software guarantees that the sample volume remains constant. An optional safety switch integrated in the pump housing immediately switches off the pump when the pump is opened (recommended if third-party staff are performing maintenance work).

### Mode of operation with a sampling assembly

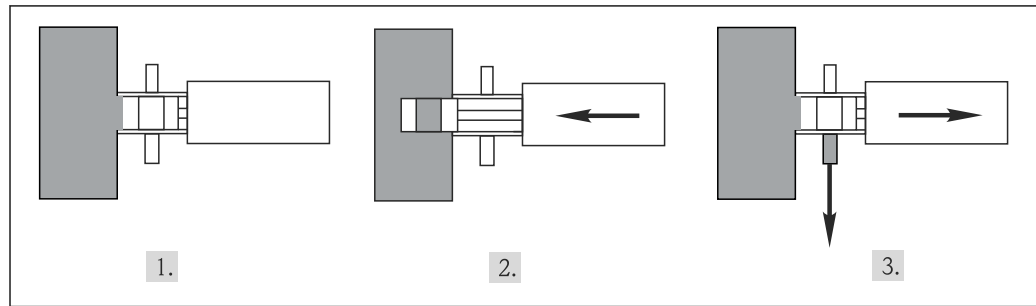

A0024344

10 Sampling steps with a sampling assembly

Sampling takes place in three steps:

1. **Standby position:** The plunger is in standby position in the assembly. The sample chamber is ventilated from the outside.
2. **Filling:** The plunger is driven by compressed air into the sample flow. An adjustable hold time allows for a representative blending of the sample in the sample chamber.
3. **Emptying:** The plunger is in standby position in the assembly. The sample chamber is ventilated from the outside. The sample is drained into the sample bottle(s).

### Sampling assembly with optional rinsing valve

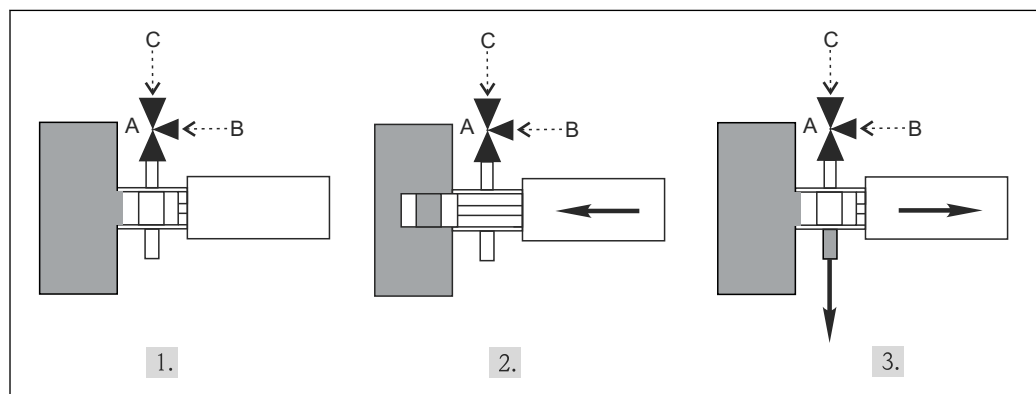

A0024345

11 Sampling steps with a sampling assembly

- A Rinsing valve  
 B Compressed air  
 C Atmosphere

The rinsing valve provides you with these additional functions:

- Draining under pressure - valve is connected to compressed air  
 In the sampling setup menu, the function "Dosing with pressure" can be selected. This allows the sample to flow under pressure into the sample bottle(s).
- Cleaning with compressed air or water  
 - In the sampling setup menu, the function "Cleaning" with air or water can be selected. Once you select "before", "after" or "before and after every sampling", you can choose a cleaning position.
- In addition, you can select sample rinsing cycles in the "Cleaning before and after sampling" menu. The system can be pre-rinsed up to 10 times with the current sample.

**i** Automatic sampling using the sampling assembly is designed for aqueous samples. For highly viscous samples, e.g. sludge >1 %, sampling can only be done directly into a container.

The air or water pressure must be set for the application in question using pressure reducing valves.

**Sampling with a flow assembly**

A flow assembly is integrated in the stand for sampling purposes.

The flow assembly is used for sampling in pressurized systems e.g.:

- Tanks positioned at a height
- Pressure piping
- Conveyance using external pumps

The flow rate should be 1000 to 1500 l/h.

**NOTICE**

**Pressure in the assembly**

Damage to the assembly

- ▶ The outlet of the flow assembly must be unpressurized (e.g. drain, open channel).

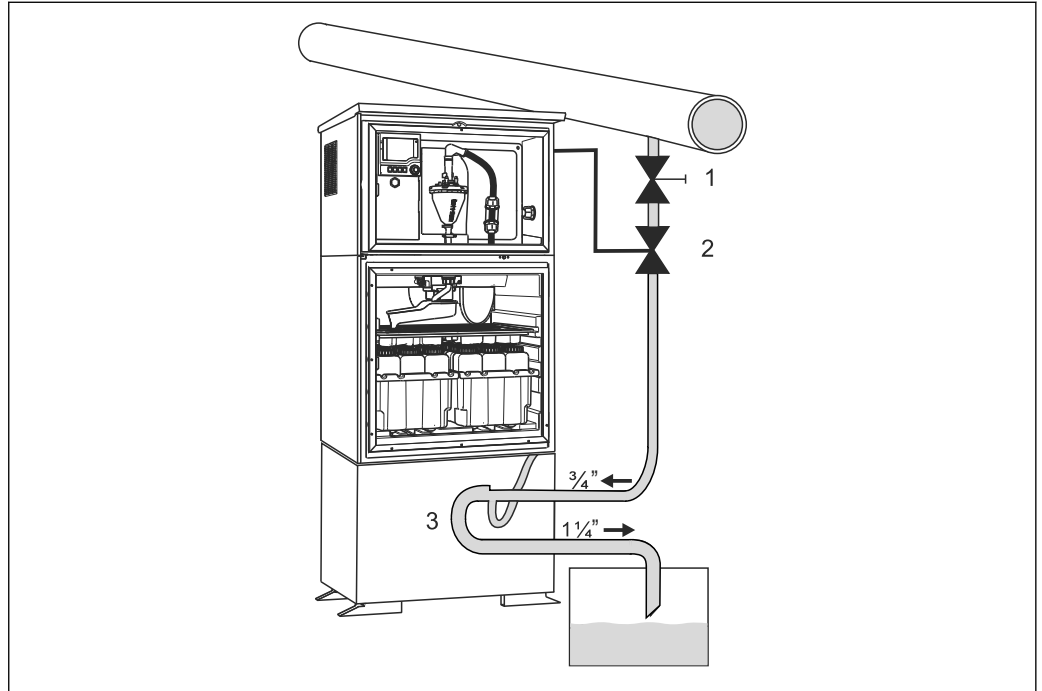

A0024346

12 Example: Sampling from pressure piping

- 1 Ball valve 1
- 2 Valve 2
- 3 Flow assembly integrated into the stand

Use the ball valve 1 to set the flow rate to 1000 l/h to 1500 l/h. When the sampling cycle begins, one of the relay outputs can be used to control and open valve 2. The medium flows through the pipe and the flow assembly and into the outflow. Once an adjustable delay time has elapsed, the sample is taken directly from the flow assembly. Valve 2 is closed again once the sample has been taken.

**i** Valve 1 and valve 2 are not included in the scope of delivery (order code TSP 71180379).

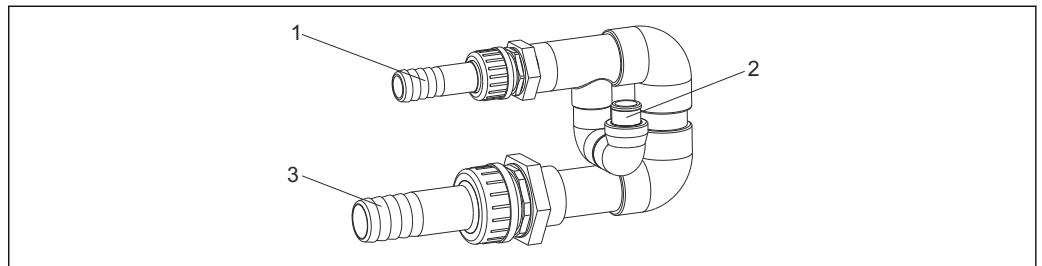

A0013127

13 Flow assembly (can also be ordered separately as kit no.: 71119408)

- Flow assembly inflow: 3/4"
- Sampling connection
- Flow assembly outflow: 1 1/4"

**Sample distribution**

The CSF48 offers many bottle combinations and distribution versions. The versions can be changed or replaced easily without the need for special tools. In addition, the software program makes it possible to configure individual bottles and bottle groups and assign them to switchover or event programs.

**Sample preservation**

The sample bottles are located in the sample compartment. This is fitted with a seamless plastic dish to ensure easy cleaning. All parts that transport medium (distribution arm, dosing system...) can be removed and cleaned easily without the need for tools.









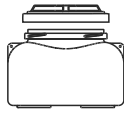
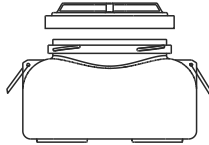
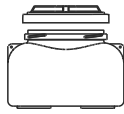

14 Distribution plate, bottle trays and distribution arm



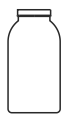
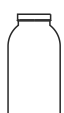

A0024347

- i** Distribution version "V": The maximum sample volume per sample is limited to 80 ml of liquid with a low solids content. A special distribution arm and distribution plate are used.
- i** Distribution version "W": This version contains one locating insert for 4 x 5000 ml Schott Duran GLS 80 glass bottles. These glass bottles must be ordered from your local Schott dealer.

Bottle groups and distribution version depending on the order version:

	CSF48-*****																			
	B	C	D	E	G	H	J	L	M	N	O	P	Q	R	S	T	U	V	W	
30 liter, PE, direct distribution  <small>A0024349</small>	1																			
60 liter, PE, direct distribution  <small>A0025843</small>		1																		
25 liter, PE, direct distribution  <small>A0024349</small>			2									1	1							

	CSF48-*****																			
	B	C	D	E	G	H	J	L	M	N	O	P	Q	R	S	T	U	V	W	
20 liter, PE, direct distribution  <small>A0025968</small>																				
17 liter, PE, direct distribution  <small>A0025967</small>														4						
13 liter, PE, direct distribution  <small>A0025968</small>			4																	
5 liter, glass, preparation  <small>A0025970</small>																				4
3.8 liter, glass, direct distribution  <small>A0025970</small>																	4			
3 liter, PE, plate distribution  <small>A0025971</small>					12			6		6				6						
2 liter, PE, plate distribution  <small>A0025856</small>																				24
1 liter, PE, plate distribution  <small>A0025972</small>						24			12	12					12					

	CSF48-*****																		
	B	C	D	E	G	H	J	L	M	N	O	P	Q	R	S	T	U	V	W
1 liter, glass, plate distribution  <small>A0025974</small>							24												
13 liter, PE, plate distribution  <small>A0025975</small>								2	2										
2 liter, PE, direct distribution  <small>A0025976</small>											12		6						
1 liter, PE, direct distribution  <small>A0025978</small>												24	12						
1.8 liter, glass, plate distribution  <small>A0025979</small>															12				

**Sampling control**

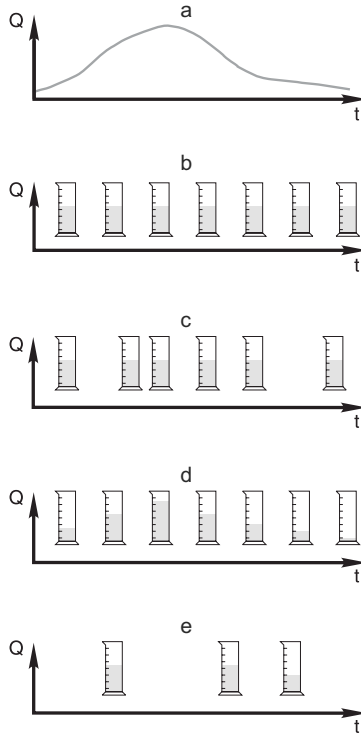

- a. **Flow curve**
- b. **Time-proportional sampling (CTCV)**  
A constant sample volume (e.g. 50 ml) is taken at regular intervals (e.g. every 5 minutes).
- c. **Volume-proportional sampling (VTCV)**  
A constant sample volume is taken at variable intervals (depending on the inflow volume).  
**i** Time override can be enabled in an advanced program. This allows long, flow-controlled sample intervals to be interrupted if the flow rate is low. A time-controlled sample is collected.
- d. **Flow-proportional sampling (CTVV)**  
A variable sample volume (the sample volume depends on the flow rate) is taken at regular intervals (e.g. every 10 min).  
**i** Only in version with peristaltic pump.
- e. **Event-controlled sampling**  
Sampling is triggered by an event (e.g. pH limit value). Sampling can be time-paced, volume-paced or flow-paced, or single samples can be taken.

15

Sampling control

A0014045

Single and multiple samples can also be grouped in a program in addition to the sampling methods listed. Furthermore, the software allows interval sampling, switchover and event functions. The latter permit up to 24 subprograms to be active simultaneously for a variety of applications. A sampling table makes it possible for users to program the bottle assignment, time interval and sample volume. Signals for external control can be connected via 2 analog inputs and 2 binary inputs in the standard version of the product. Customized text is entered to ensure the correct assignment of the inputs in the memory.

### Intake speed with different suction lines

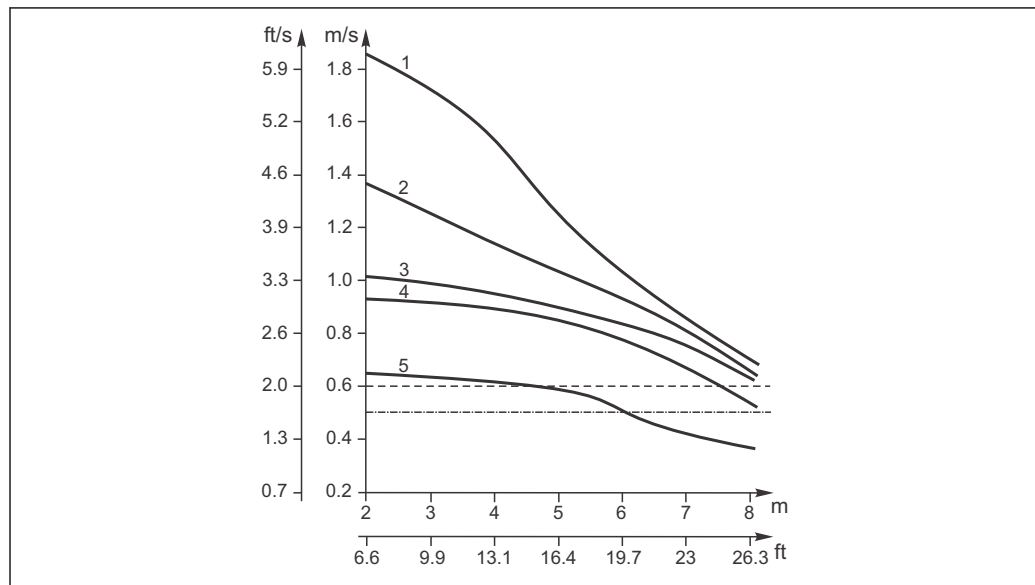

A0024350

16 Intake speed in m/s with suction height in m

- a Intake speed as per Ö 5893; US EPA  
 b Intake speed as per EN 25667, ISO 5667  
 1 ID 10 mm (3/8") vacuum pump  
 2 ID 13 mm (1/2") vacuum pump  
 3 ID 10 mm (3/8") peristaltic pump  
 4 ID 16 mm (5/8") vacuum pump  
 5 ID 19 mm (3/4") vacuum pump

### Sample temperature regulation (optional)

The temperature of the sample compartment can be adjusted using the controller. The factory setting is 4 °C (39 °F). The current temperature is shown on the display and can be recorded in the internal data logger.

A temperature sensor for measuring individual sample temperatures can be ordered as an option.

The vaporizer and defrost heater are integrated in a special housing such that they are protected against corrosion and damage. The compressor and condenser are located in the upper section of the sampler. They can be easily accessed by removing the upper rear panel (for maintenance purposes).



A0024355

17 Cooling system



### Sampler housing

Pay attention to the installation conditions in the "Installation" section and the information on the materials of the different housing types in the "Mechanical construction" section.

#### **NOTICE**

**The plastic material polystyrene VO can discolor if exposed directly to sunlight.**

In the case of stainless steel housings, the frame around the window can discolor if exposed directly to sunlight.

- ▶ The plastic material ASA+PC VO is recommended for outdoor installations where a sun guard is not used. The discoloring does not affect the function and operation of the device.

## Equipment architecture

### Slot and port assignment

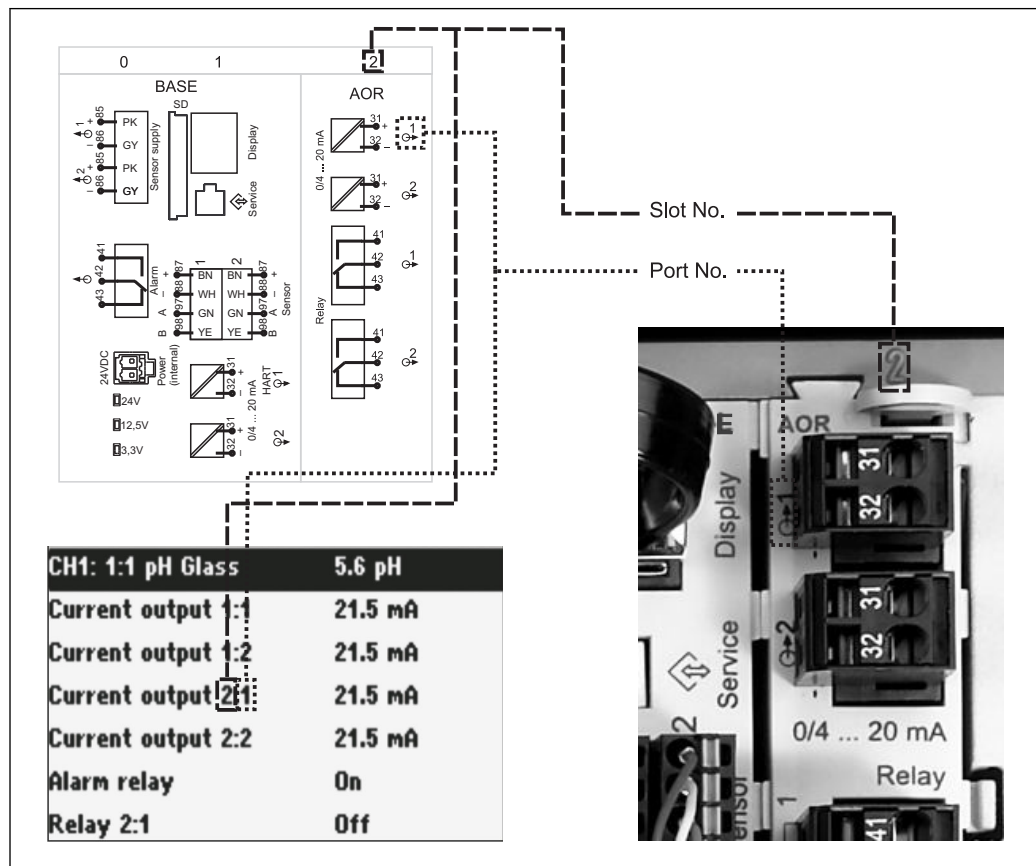

A0016633-EN

18 Slot and port assignment of hardware and presentation on the display

#### The electronics configuration follows a modular concept:

- There are several slots for electronics modules.
- These slots are numbered consecutively in the housing. Slots 0 and 1 are always reserved for the basic module.
- In addition there are also inputs and outputs for the control module. These slots are labeled "S".
- Each electronics module has one or more inputs and outputs or relays. Here they are all collectively known as "ports".
- Ports are consecutively numbered per electronics module and are recognized automatically by the software.

- Outputs and relays are named according to their function, e.g. "current output", and are displayed in ascending order with the slot and port numbers.

Example:

"Current output 2:1" shown on the display means: slot 2 (e.g. AOR module) : port 1 (current output 1 of the AOR module)

- Inputs are assigned to measuring channels in the ascending order of "slot:port number"

Example:

"CH1: 1:1" shown on the display means:

Slot 1 (base module) : port 1 (input 1) is channel 1 (CH1) and a conductivity sensor is connected here.

## Communication and data processing

### Communication protocols:

- Fieldbus systems
  - HART
  - PROFIBUS DP (Profile 3.02)
  - Modbus TCP or RS485
  - PROFINET
  - Ethernet/IP
- Configuration via Ethernet



Only one type of fieldbus communication can ever be active. The last activation code entered decides which bus is used.

The device drivers available make it possible to perform a basic setup and display measured values and diagnostics information via the fieldbus. A full device configuration via the fieldbus is not possible.

### Bus termination on the device

- Via slide switch at bus module 485
- Displayed via LED "T" on bus module 485

## Dependability

### Reliability

#### Memosens technology



Memosens makes your measuring point safer and more reliable:

- Non-contact, digital signal transmission enables optimum galvanic isolation
- No contact corrosion
- Completely watertight
- Laboratory sensor calibration possible, thus increasing measured value availability
- Predictive maintenance thanks to recording of sensor data, e.g.:
  - Total hours of operation
  - Hours of operation with very high or very low measured values
  - Hours of operation at high temperatures
  - Number of steam sterilizations
  - Sensor condition



A0024356

#### Sensor check system (SCS)

The sensor check system (SCS) monitors the high impedance of the pH glass. An alarm is triggered if a minimum impedance value is undershot or a maximum impedance is exceeded.

- Glass breakage is the main reason for a drop in high impedance values.
- The causes of increasing impedance values are:
  - Dry sensor
  - Worn pH glass membrane

#### Process check system (PCS)

The process check system (PCS) checks the measuring signal for stagnation. An alarm is triggered if the measuring signal does not change over a certain period (several measured values).

#### The main causes of stagnating measured values are:

- Sensor fouled or outside the medium
- Sensor defective
- Process error (e.g. through control system)

#### Sensor condition check (SCC)

This function monitors the electrode condition and the degree of electrode aging. The status is indicated by the messages "SCC electrode condition bad" or "SCC electrode condition OK". The electrode condition is updated after every calibration.

### Maintainability

#### Modular design

The modular sampler design means it can be easily adapted to suit your needs:

- Retrofit extension modules for new or extended range of functions, e.g. current outputs and relays
- Upgrade from one channel to multichannel measurement with digital sensors
- Upgrade to fieldbus communication (PROFIBUS DP, Modbus TCP, Modbus RS485, Ethernet, PROFINET for configuration and EtherNet/IP)

#### Memory

- Independent, integrated ring memories (FIFO) or stack memories for recording:
  - An analog value (e.g. flow, pH value, conductivity)
  - Events (e.g. power failure)
  - Sample statistics (e.g. sampling volume, filling times, bottle assignment)
- Program memory: max. 100 programs
- Data logbooks:
  - Adjustable scan time: 1 to 3600 s (1 h)
  - Max. 8 data logbooks
  - 150,000 entries per logbook
  - Graphic display (load curves) or numerical list
- Calibration logbook: max. 75 entries

- Hardware logbook:
  - Hardware configuration and modifications
  - Max. 125 entries
- Version logbook:
  - Including software updates
  - Max. 50 entries
- Operations logbook: max. 250 entries
- Diagnostic logbook: max. 250 entries

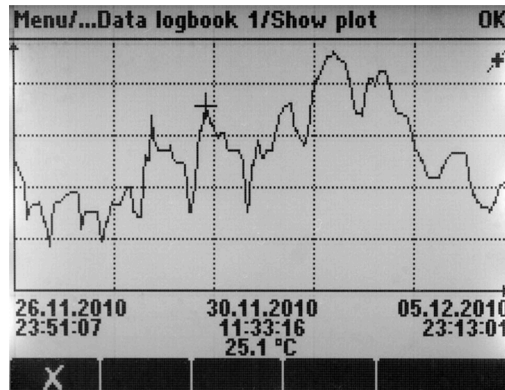

19 Data logbook: graphic display

A0024359

### Mathematical functions (virtual process values)

In addition to "real" process values, which are provided by connected physical sensors or analog inputs, mathematical functions can be used to calculate a maximum of 6 "virtual" process values.

#### The "virtual" process values can be:

- Output via a current output or a fieldbus
- Used as a regulating control variable
- Assigned as a measured variable to a limit contactor
- Used as a measured variable to trigger cleaning
- Displayed in user-defined measuring menus

#### The following mathematical functions are possible:

- Calculation of pH from two conductivity values according to VGB Standard 405, e.g. in boiler feedwater
- Difference between two measured values from different sources, e.g. to monitor membranes
- Differential conductivity, e.g. to monitor the efficiency of ion exchangers
- Degassed conductivity, e.g. for process controls in power plants
- Redundancy to monitor two or three redundant sensors
- rH calculation from the measured values of a pH and an ORP sensor

### FieldCare and Field Data Manager

#### FieldCare

Configuration and asset management software based on FDT/DTM technology

- Complete device configuration when connected via FXA291 and service interface
- Access to a number of configuration parameters and identification, measuring and diagnostic data when connected via HART modem
- Logbooks can be downloaded in CSV format or binary format for "Field Data Manager" software

#### Field Data Manager

Visualization software and database for measuring, calibration and configuration data

- SQL database which is protected against manipulation
- Functions to import, save and print out logbooks
- Load curves to display measured values
- All the logbooks can be read out and saved online

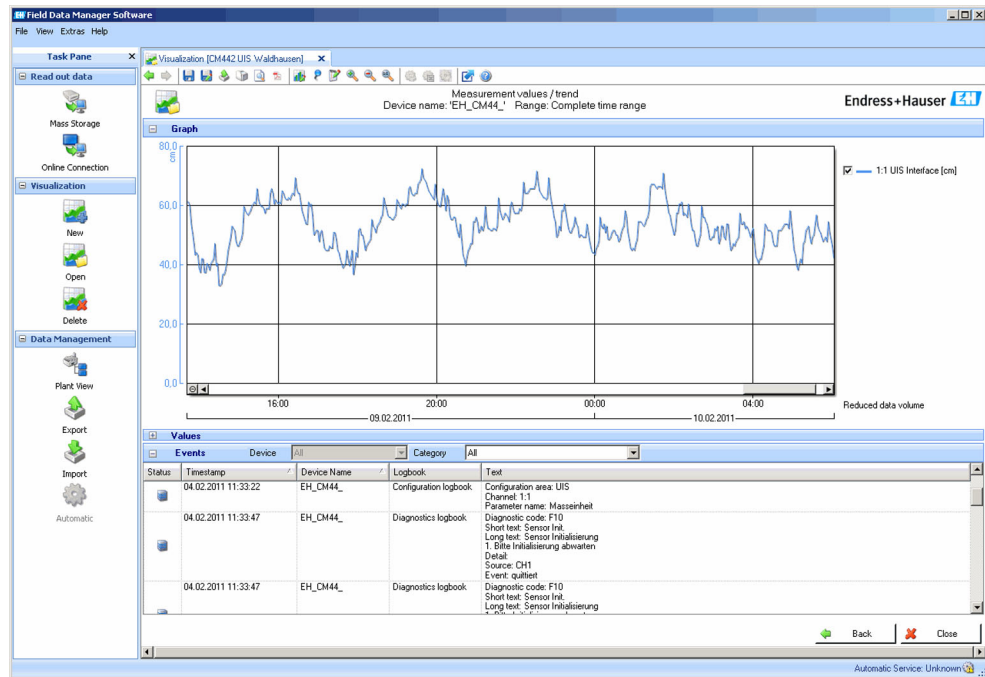

A0016009

20 Field Data Manager: load curves

### SD card

The exchangeable storage medium enables:

- Quick and easy software updates and upgrades
- Data storage of internal device memory (e.g. logbooks)
- Transfer of complete configurations to a device with an identical setup (backup function)
- Transfer of configurations without the TAG and bus address to devices with an identical setup (copy function)

Endress+Hauser offers industry-approved SD cards as accessories. These memory cards provide maximum data security and integrity.

Other SD cards can also be used. However, Endress+Hauser does not accept any responsibility for the data security of such cards.

## Safety

### Real-time clock

The device has a real-time clock, which is backed up by a button cell in the event of a power failure. This ensures that the device continues to keep the correct time and date if it is restarted and that the time stamp for the logbooks is correct.

### Data security

All settings, logbooks etc. are stored in a non-volatile memory to ensure that the data are retained even in the event of a disruption to the power supply.

## Input

### Types of input

- 2 analog inputs
- 2 binary inputs + 4 binary inputs (optional)
- 1 to 4 digital inputs for sensors with Memosens protocol (optional)

### Measured values

→ Documentation of the connected sensor

## Temperature inputs

<b>Measuring range</b>	<b>Measuring range</b> -30 to 70 °C (-20 to 160 °F)
<b>Type of input</b>	Pt1000
<b>Accuracy</b>	± 0.5 K

## Binary input, passive

<b>Span</b>	12 to 30 V, galvanically isolated
<b>Signal characteristics</b>	Minimum pulse width: 100 ms
<b>Accuracy</b>	± 0.5 K

## Analog input, passive/active

<b>Span</b>	0/4 to 20 mA, galvanically isolated
<b>Accuracy</b>	±0.5 % of measuring range

## Output

<b>Output signal</b>	<ul style="list-style-type: none"> <li>▪ 2 binary outputs (standard) + 2 binary outputs (optional): Open collector, max. 30 V, 200 mA</li> <li>▪ Up to 2 x 0/4 to 20 mA, active, galvanically isolated from the sensor circuits and from each other</li> <li>▪ 2 to 6 x 0/4 to 20 mA, active, galvanically isolated from the sensor circuits and from each other</li> <li>▪ Of those, 1 x with optional HART communication (only via current output 1:1). Limited to 2 current outputs with optional fieldbus communication.</li> </ul>
<b>Communication</b>	<ul style="list-style-type: none"> <li>▪ 1 service interface</li> <li>▪ Accessible via front panel connection (optional)</li> <li>▪ Commubox FXA291 (accessory) required for communication with the PC</li> </ul>
<b>Output signal</b>	<p>Depending on version:</p> <ul style="list-style-type: none"> <li>▪ 2 x 0/4 to 20 mA, active, galvanically isolated from one another and from the sensor circuits</li> <li>▪ 4 x 0/4 to 20 mA, active, galvanically isolated from one another and from the sensor circuits</li> <li>▪ 6 x 0/4 to 20 mA, active, galvanically isolated from one another and from the sensor circuits</li> <li>▪ 8 x 0/4 to 20 mA, active, galvanically isolated from one another and from the sensor circuits</li> <li>▪ Optional HART communication (only via current output 1:1)</li> </ul>

HART	
Signal encoding	FSK ± 0.5 mA via current signal
Data transmission rate	1200 baud
Galvanic isolation	Yes
Load (communication resistor)	250 Ω

<b>PROFIBUS DP/RS485</b>	
Signal encoding	EIA/TIA-485, PROFIBUS DP-compliant acc. to IEC 61158
Data transmission rate	9.6 kBd, 19.2 kBd, 45.45kBd, 93.75 kBd, 187.5 kBd, 500 kBd, 1.5 MBd, 6 MBd, 12 MBd
Galvanic isolation	Yes
Connectors	Spring terminal (max. 1.5 mm), bridged internally (T-function), optional M12
Bus termination	Internal slide switch with LED display

<b>Modbus RS485</b>	
Signal encoding	EIA/TIA-485
Data transmission rate	2,400, 4,800, 9,600, 19,200, 38,400, 57,600 and 115,200 baud
Galvanic isolation	Yes
Connectors	Spring terminal (max. 1.5 mm), bridged internally (T-function), optional M12
Bus termination	Internal slide switch with LED display

<b>Ethernet and Modbus TCP</b>	
Signal encoding	IEEE 802.3 (Ethernet)
Data transmission rate	10/100 MBd
Galvanic isolation	Yes
Connection	RJ45
IP address	DHCP (default) or configuration via menu

<b>Ethernet/IP</b>	
Signal encoding	IEEE 802.3 (Ethernet)
Data transmission rate	10/100 MBd
Galvanic isolation	Yes
Connection	RJ45
IP address	DHCP (default) or configuration via menu

<b>PROFINET</b>	
Signal encoding	IEEE 802.3 (Ethernet)
Data transmission rate	100 MBd
Galvanic isolation	Yes
Connection	RJ45
Name of station	Via DCP protocol using the configuration tool (e.g. Siemens PRONETA)
IP address	Via DCP protocol using the configuration tool (e.g. Siemens PRONETA)



## Current outputs, active

---

<b>Span</b>	0 to 23 mA 2.4 to 23 mA for HART communication
<b>Signal characteristic</b>	Linear
<b>Signal on alarm</b>	Adjustable, as per NAMUR Recommendation NE 43 <ul style="list-style-type: none"><li>■ In measuring range 0 to 20 mA (HART is not available with this measuring range): Failure current from 0 to 23 mA</li><li>■ In measuring range 4 to 20 mA: Failure current from 2.4 to 23 mA</li><li>■ Factory setting for failure current for both measuring ranges: 21.5 mA</li></ul>
<b>Load</b>	Max. 500 $\Omega$
<b>Electrical specification</b>	<b>Output voltage</b> Max. 24 V
<b>Cable specification</b>	<b>Cable type</b> Recommended: shielded cable  <b>Cross-section</b> Recommended: shielded cable

## Relay outputs

### Electrical specification

#### Relay types

- 2 x changeover contact, coupled with binary output (optional)
- 1 single-pin changeover contact (alarm relay)
- 1 relay card with 2 or 4 relays (optional)

#### Maximum load

- Alarm relay: 0.5 A
- All other relays: 2.0 A

#### Relay switching capacity

*Power unit (Alarm relay)*

Switching voltage	Load (max.)	Switching cycles (min.)
230 V AC, $\cos\Phi = 0.8$ to 1	0.1 A	700,000
	0.5 A	450,000
24 V DC, L/R = 0 to 1 ms	0.1 A	500,000
	0.5 A	350,000

*Relay coupled with binary output*

Switching voltage	Load (max.)	Switching cycles (min.)
230 V AC, $\cos\Phi = 0.8$ to 1	5 A	100,000
24 V DC, L/R = 0 to 1 ms	5 A	100,000

*Extension module*

Switching voltage	Load (max.)	Switching cycles (min.)
230 V AC, $\cos\Phi = 0.8$ to 1	0.1 A	700,000
	2 A	120,000
	115 V AC, $\cos\Phi = 0.8$ to 1	0.1 A
2 A		170,000
24 V DC, L/R = 0 to 1 ms	0.1 A	500,000
	2 A	150,000

*Minimum load (typical)*

- Min. 100 mA at 5 V DC
- Min. 1 mA at 24 V DC
- Min. 5 mA at 24 V AC
- Min. 1 mA at 230 V AC

## Protocol-specific data

<b>HART</b>	Manufacturer ID	11 <sub>h</sub>
	Device type	119D <sub>h</sub>
	Device revision	001 <sub>h</sub>
	Device description files (DD/DTM)	<a href="http://www.endress.com/hart">www.endress.com/hart</a> Device Integration Manager DIM
	Device variables	
	Supported features	PDM DD, AMS DD, DTM,

<b>PROFIBUS DP</b>	Manufacturer ID	11 <sub>h</sub>
	Device type	155C <sub>h</sub>
	Profile version	3.02
	GSD files	<a href="http://www.endress.com/profibus">www.endress.com/profibus</a> Device Integration Manager DIM
	Output values	
	Supported features	<ul style="list-style-type: none"> <li>▪ 1 MSCY0 connection (cyclical communication, master class 1 to slave)</li> <li>▪ 1 MSAC1 connection (acyclical communication, master class 1 to slave)</li> <li>▪ 2 MSAC2 connections (acyclical communication, master class 2 to slave)</li> <li>▪ Addressing using DIL switches or software</li> <li>▪ GSD, PDM DD, DTM</li> </ul>

<b>Modbus RS485</b>	Protocol	RTU/ASCII
	Function codes	03, 04, 06, 08, 16, 23
	Broadcast support for function codes	06, 16, 23
	Output data	16 measured values (value, unit, status), 8 digital values (value, status)
	Input data	4 setpoints (value, unit, status), 8 digital values (value, status), diagnostic information
	Supported features	Address can be configured using switch or software

<b>Modbus TCP</b>	TCP port	502
	TCP connections	3
	Protocol	TCP
	Function codes	03, 04, 06, 08, 16, 23
	Broadcast support for function codes	06, 16, 23
	Output data	16 measured values (value, unit, status), 8 digital values (value, status)
	Input data	4 setpoints (value, unit, status), 8 digital values (value, status), diagnostic information
	Supported features	Address can be configured using DHCP or software

**Ethernet/IP**

Log	EtherNet/IP	
ODVA certification	Yes	
Device profile	Generic device (product type: 0x2B)	
Manufacturer ID	0x049E <sub>h</sub>	
Device type ID	0x109	
Polarity	Auto-MIDI-X	
Connections	CIP	12
	I/O	6
	Explicit message	6
	Multicast	3 consumers
Minimum RPI	100 ms (default)	
Maximum RPI	10000 ms	
System integration	EtherNet/IP	EDS
	Rockwell	Add-on-Profile Level 3, Faceplate for Factory Talk SE
IO data	Input (T → O)	Device status and diagnostic message with highest priority  Measured values: <ul style="list-style-type: none"> <li>▪ 16 AI (analog input) + Status + Unit</li> <li>▪ 8 DI (discrete input) + Status</li> </ul>
	Output (O → T)	Actuating values: <ul style="list-style-type: none"> <li>▪ 4 AO (analog output) + status + unit</li> <li>▪ 8 DO (discrete output) + Status</li> </ul>

**Web server**

The Web server enables full access to the device configuration, measured values, diagnostic messages, logbooks and service data via standard WiFi/WLAN/LAN/GSM or 3G routers with a user-defined IP address.

TCP port	80
Supported features	<ul style="list-style-type: none"> <li>▪ Remote-controlled device configuration</li> <li>▪ Save/restore device configuration (via SD card)</li> <li>▪ Logbook export (file formats: CSV, FDM)</li> <li>▪ Access to Web server via DTM or Internet Explorer</li> </ul>

## Power supply

---

**Electrical connection** --> For a detailed connection plan, see the Operating Instructions for Liquistation CSF48

---

**Supply voltage** Depending on version:

- 100 to 120/200 to 240 V AC  $\pm 10\%$ , 50/60 Hz
- 24 V DC  $+15/-9\%$

---

**Cable entries** Depending on version:

- 1 x M25, 7 x M20 cable gland
- 1 x M25, 1 x M20 cable gland

Permitted cable diameter:

- M20x1.5 mm: 7 to 13 mm (0.28 to 0.51")
- M25x1.5 mm: 9 to 17 mm (0.20 to 0.67")

---

**Mains fuse**

- T3.15A (for 230V power supply)
- T10A (for 24V power supply)
- T10A (fuse for battery backup)
- For version with cCSAus approval: T4A (for cooling module)

---

**Power consumption**

- Version with vacuum pump: 290 VA
- Version with peristaltic pump: 290 VA
- Version with sampling assembly: 290 VA
- Version with 24V power supply: 240 W

---

**Power failure** Power supply (optional): 2 x 12 V, 7.2 Ah, with additional charge controller

 Replace the rechargeable batteries with type Panasonic LC-R127R2PG1.

Real-time clock: lithium battery, type CR2032

## Performance characteristics

<b>Sampling methods</b>	<p><b>Vacuum pump/peristaltic pump/sampling assembly:</b></p> <ul style="list-style-type: none"> <li>■ Event sampling</li> <li>■ Single and multiple samples</li> <li>■ Sampling table</li> </ul> <p><b>Vacuum pump:</b></p> <ul style="list-style-type: none"> <li>■ Time-paced</li> <li>■ In proportion to volume</li> </ul> <p><b>Peristaltic pump:</b></p> <ul style="list-style-type: none"> <li>■ Time-paced</li> <li>■ In proportion to volume</li> <li>■ Flow proportional sampling/time override (CTVV)</li> </ul>
<b>Dosing volume</b>	<p><b>Vacuum pump:</b> 20 to 350 ml (0.7 to 12 fl.oz.)</p> <p><b>Peristaltic pump:</b> 10 to 10000 ml (0.3 to 340 fl.oz.)</p> <p> The dosing accuracy and the repeatability of a sample volume &lt; 20 ml can vary, depending on the specific application.</p> <p><b>Sampling assembly:</b> 10, 30 or 50 ml (0.3; 1 or 1.7 fl.oz.)</p>
<b>Dosing accuracy</b>	<ul style="list-style-type: none"> <li>■ <b>Vacuum pump:</b> ± 5 ml (0.17 fl.oz.) or 5 % of the set volume</li> <li>■ <b>Peristaltic pump:</b> ± 5 ml (0.17 fl.oz.) or 5 % of the set volume</li> <li>■ <b>Sampling assembly:</b> ± 2 ml (0.07 fl.oz.)</li> </ul>
<b>Repeatability</b>	5 %
<b>Intake speed</b>	<p>&gt; 0.5 m/s (&gt; 1.6 ft/s) for ≤ 13 mm (1/2") ID, as per EN 25667, ISO 5667, CEN 16479-1</p> <p>&gt; 0.6 m/s (&gt; 1.9 ft/s) for 10 mm (3/8") ID, in accordance with Ö 5893; US EPA</p>
<b>Suction height</b>	<ul style="list-style-type: none"> <li>■ <b>Vacuum pump:</b> Max. 6 m (20 ft) or max. 8 m (26 ft), depending on the version</li> <li>■ <b>Peristaltic pump:</b> Max. 8 m (26 ft)</li> </ul>
<b>Hose length</b>	Max. 30 m (98 ft)
<b>Sample supply, sampling assembly</b>	<ul style="list-style-type: none"> <li>■ Minimum height difference: 0.5 m (1.6 ft)</li> <li>■ Maximum hose length: 5 m (16 ft)</li> <li>■ Material: EPDM black, 13 mm ID</li> </ul>
<b>Temperature control</b>	<p><b>Temperature sensors:</b></p> <ul style="list-style-type: none"> <li>■ Sampling compartment temperature</li> <li>■ Sample temperature (optional)</li> <li>■ Outside temperature (optional)</li> </ul> <p><b>Cooling module:</b></p> <ul style="list-style-type: none"> <li>■ Sample temperature range: 2 to 20 °C (36 to 68 °F) Factory setting: 4 °C (39 °F)</li> <li>■ Automatic defrost system</li> <li>■ Cooling rate in accordance with Ö 5893 (Austrian standard): 4 liters of water at 20 °C cool down to 4 °C in less than 210 minutes</li> <li>■ Temperature constancy of sample at 4 °C over the operating temperature range of -15 to 40 °C (5 to 105 °F)</li> </ul>

## Installation

### Installation instructions

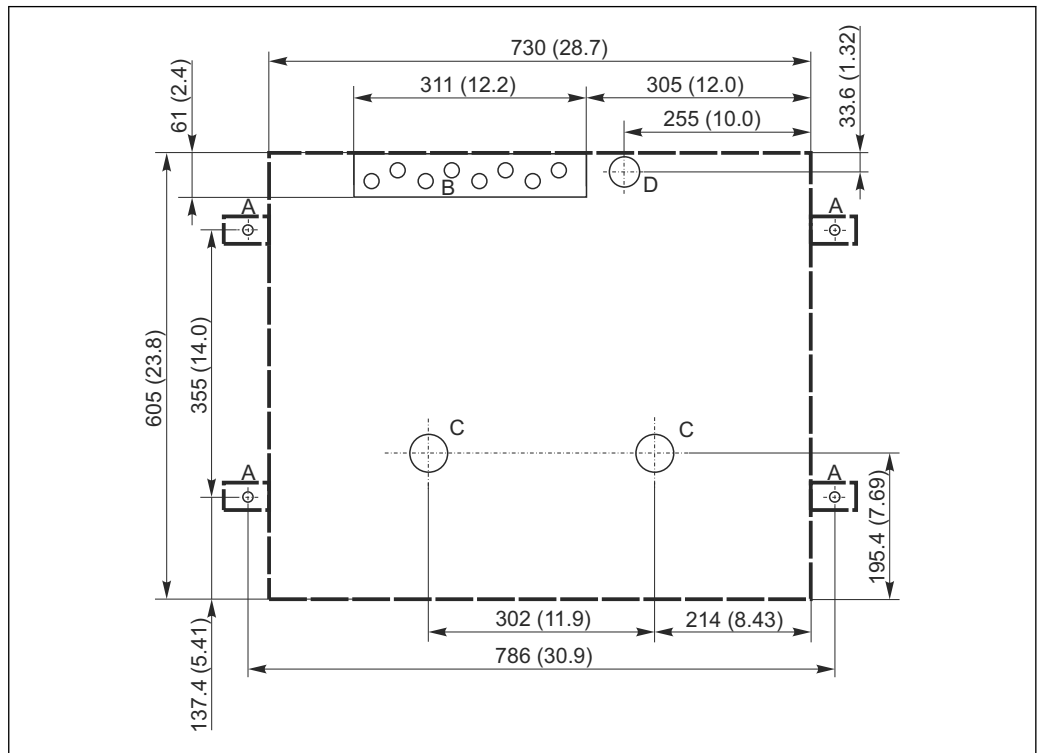

A0024406

21 Foundation plan

- A Fasteners (4 x M10)
- B Cable inlet
- C Outlet for condensate and overflow > DN 50
- D Sample supply from below > DN 80
- Dimensions of Liquistation

### Mounting conditions

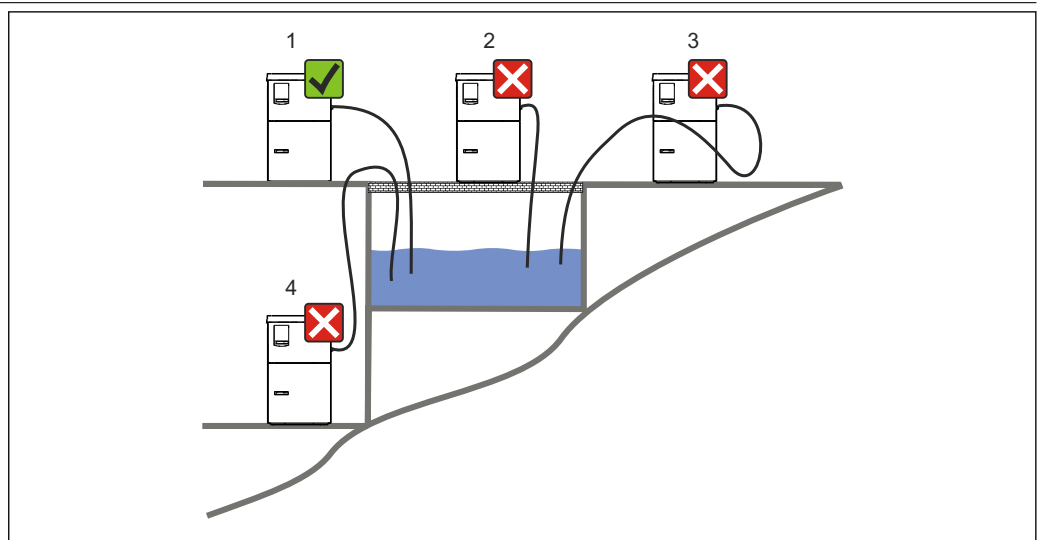

A0024411

22 Liquistation mounting conditions

1. Correct
  - ↳ The suction line must be routed with a downward slope to the sampling point.
2. Incorrect
  - ↳ The sampler should never be mounted in a place where it is exposed to aggressive gases.

3. Incorrect
  - ↳ Avoid siphoning effects in the suction line.
4. Incorrect
  - ↳ The suction pipe should never be routed with an upward gradient to the sampling point.

Note the following when erecting the device:

- Erect the device on a level surface.
- Securely connect the device at the fastening points to the surface underneath.
- Protect the device against additional heating (e.g. heater or direct sunlight in the case of PS housing).
- Protect the device against mechanical vibrations.
- Protect the device against strong magnetic fields.
- Make sure air can circulate freely at the side panels of the cabinet. Do not mount the device directly against a wall. Allow at least 150 mm (5.9") from the wall to the left and right.
- Do not erect the device directly above the inlet channel of a wastewater treatment plant.

#### Installation conditions for sampling assembly Samplefit CSA420

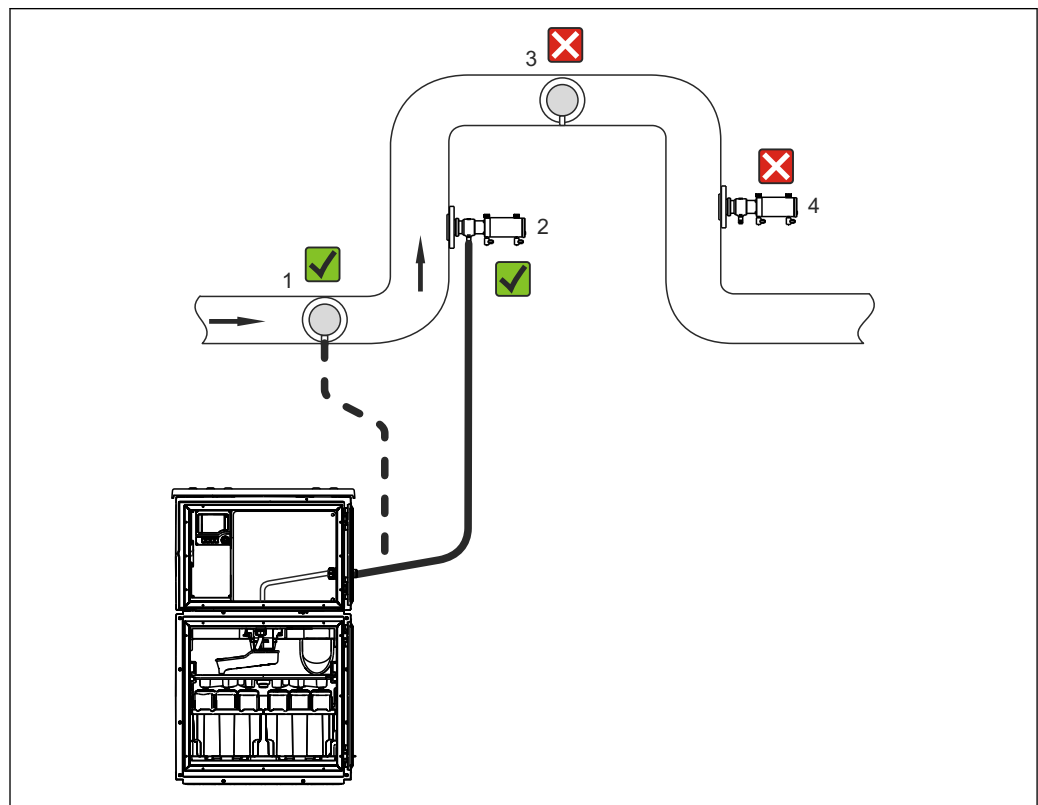

23 Installation conditions for Liquistation CSF48 with Samplefit CSA420 sampling assembly

Note the following when installing the sampling assembly in a pipe:

- The best installation location is in the ascending pipe (pos. 2). Installation is also possible in the horizontal pipe (pos. 1).
- Avoid installation in the down pipe (pos. 4).
- Avoid siphoning effects in the sample line.
- The minimum vertical distance between the assembly and the inlet of the sampler should be at least 0.5 m (1.65 ft).

Note the following when erecting the sampler:

- Erect the device on a level surface.
- Protect the device against additional heating (e.g. from a heating system).
- Protect the device against mechanical vibrations.
- Protect the device against strong magnetic fields.
- Make sure air can circulate freely at the side panels of the cabinet. Do not mount the device directly against a wall. Allow at least 150 mm (5.9") from the wall to the left and right.
- Do not erect the device directly above the inlet channel of a wastewater treatment plant.



## Environment

---

<b>Ambient temperature</b>	With cooling module:	-20 to 40 °C (0 to 104 °F)
	Without cooling module:	0 to 40 °C (32 to 104 °F)
	With ASA+PC or stainless steel housing:	-20 to 40 °C (0 to 104 °F)
	With plastic polystyrene housing:	0 to 40 °C (32 to 104 °F)
<b>Storage temperature</b>	-20 to 60 °C (-4 to 140 °F)	
<b>Degree of protection</b>	<ul style="list-style-type: none"><li>■ Front dosing compartment: IP 54</li><li>■ Rear dosing compartment: IP 33</li><li>■ Front panel with display (internal): IP 65</li><li>■ Sample compartment: IP 54</li></ul>	
<b>Electromagnetic compatibility</b>	Interference emission and interference immunity as per EN 61326-1:2006, class A for industry	
<b>Electrical safety</b>	In accordance with EN 61010-1, protection class I, environment ≤ 2000 m (6500 ft) above MSL. The device is designed for pollution degree 2.	
<b>Relative humidity</b>	10 to 95%, not condensing	

## Process

---

**Process temperature** 2 to 50 °C (36 to 122 °F)

---

**Process characteristics**

**Vacuum pump**  
 Capacitance level measurement used for:

- Sample media has to be free of abrasive substances.
- Media that tend to create a lot of foam or contain fats and grease
- Media with a conductivity < 30 µS/cm

**Peristaltic pump**  
 Sample media has to be free of abrasive substances.

**Sampling assembly**

- Sample media has to be free of abrasive substances.
- The distributor version of the device cannot be used for sample media with a solids content in excess of 1 %. The sample must be transferred directly to a bottle or a container.

 Pay attention to the material compatibility of the wetted parts.

---

**Process pressure**

- Unpressurized, open channel (unpressurized sampling)
- Max. 0.8 bar piping (only with shutoff/inlet valve)

**Sampling assembly:**  
 Max. 6 bar

---

**Process connection**

- **Vacuum pump:**  
 Suction line ID 10 mm (3/8"), 13 mm (1/2"), 16 mm (5/8") or 19 mm (3/4")
- **Peristaltic pump:**  
 Intake hose ID 10 mm (3/8")
- **Sampling assembly:**
  - Flange DN50, PP
  - Triclampe DN50, DIN 32676

Process connection for  
sampling assembly Samplefit  
CSA420

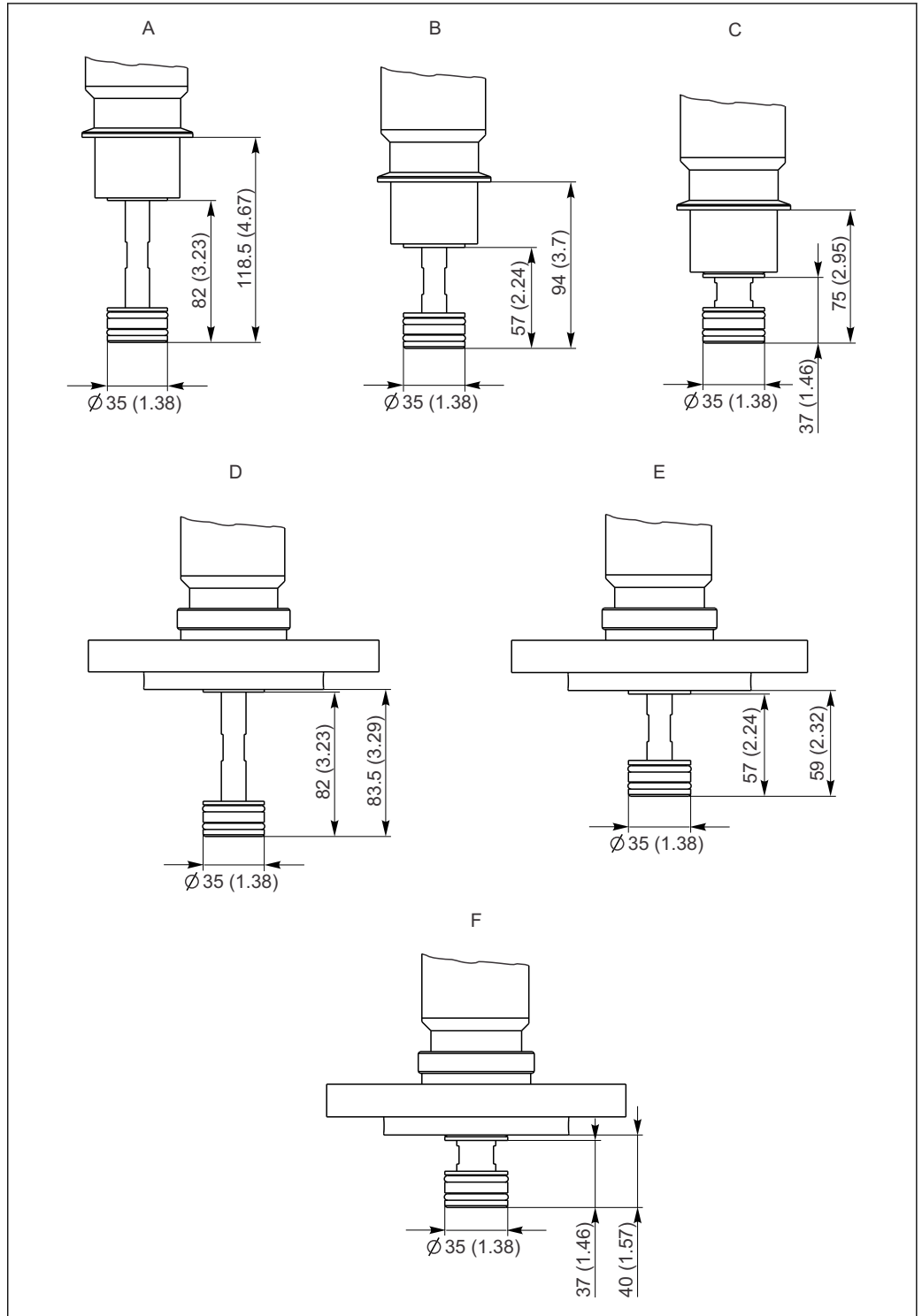

A0025980

24 Samplefit CSA420. Engineering unit in mm (inch)

- A Triclamp DN50, 50ml version
- B Triclamp DN50, 30ml version
- C Triclamp DN50, 10ml version
- D Flange DN50, 50ml version
- F Flange DN50, 30ml version
- D Flange DN50, 10ml version

## Mechanical construction

### Dimensions

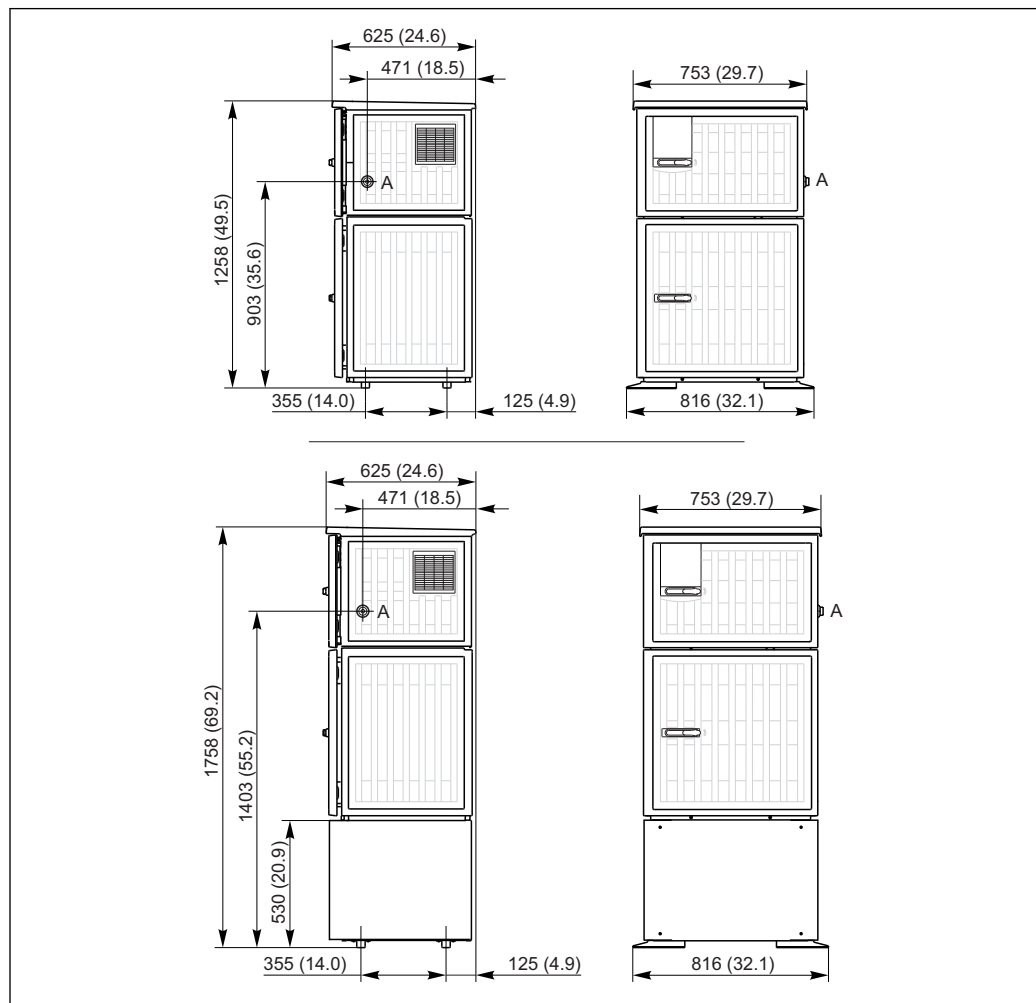

A0025857

25 Dimensions of Liquistation CSF48 plastic version, without/with stand, dimensions in mm (in)

A Suction line connection

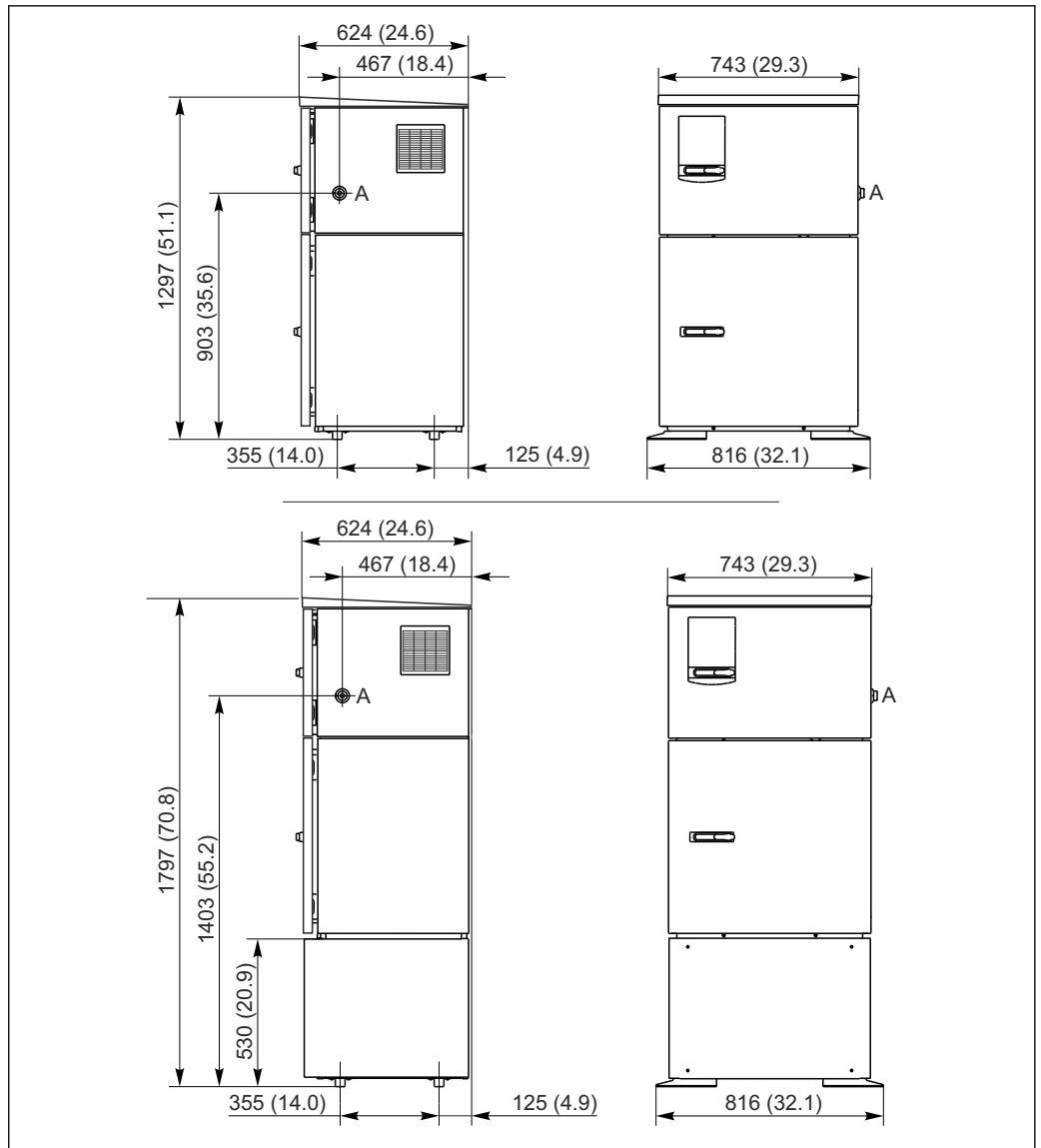

A0024423

26 Dimensions of Liquistation CSF48 CSF34 stainless steel version, without/with stand, dimensions in mm (in)

A Suction line connection

**Weight**

Sampler version	Weight
Plastic version without refrigeration	91 kg (201 lbs)
Plastic version with refrigeration	101 kg (223 lbs)
Plastic version without refrigeration and with fixed castor frame	105 kg (232 lbs)
Stainless steel version with refrigeration	118 kg (260 lbs)
Stainless steel version with stand and refrigeration	146 kg (322 lbs)

## Materials

 Plastic polystyrene VO can change color when exposed to direct sunlight. For outdoor use without a weather protection cover, the use of Plastic ASA+PC VO is recommended. The functionality is not affected by the discoloration.

Non-wetted parts	
Cabinet housing	<p><b>Plastic polystyrene VO</b> For standard applications in wastewater treatment plants and environmental monitoring</p> <p><b>Plastic ASA+PC VO</b> For industrial wastewater treatment plants with an aggressive atmosphere</p> <p><b>Stainless steel V2A (1.4301)</b> For standard applications in wastewater treatment plants and environmental monitoring</p> <p><b>Stainless steel V4A (1.4571)</b> For industrial wastewater treatment plants with an aggressive atmosphere</p>
Sample compartment inner lining	Plastic PP
Window	Safety glass, coated
Insulation	Plastic EPS "Neopor®"

Wetted parts	Vacuum pump	Peristaltic pump	Sampling assembly:
Dosing tube	Plastic PP	-	-
Dosing chamber cover	Plastic PP	-	-
Conductivity sensors	Stainless steel V4A (1.4404)	-	-
Capacitance sensor	PSU	-	-
Dosing chamber	PMMA, glass (depending on version)	-	-
Dosing system outflow hose	Silicone	-	EPDM
Pump tubing	-	Silicone	-
Process seal	-	-	Viton EPDM Kalrez
Distribution arm	Plastic PP		
Distribution arm cover	Plastic PE		
Distribution plate	Plastic PS		
Composite container/bottles	Plastic PE, glass (depending on version)		
Intake hose	Plastic PVC, EPDM (depending on version)		
Hose connection	Plastic PP		
Rinse connection	-	-	Plastic PP

 Choose process seal depending on the application. Viton is recommended for standard applications involving watery samples.

Vacuum pump only	
Pneumatic hoses	Silicone
Air Manager housing	PC
Air Manager sealing plate	Silicone
Pump head	Aluminum, anodized
Pump membrane	EPDM

## Operability

### Operating concept

The simple and structured operating concept sets new standards:

- Intuitive operation with the navigator and soft keys
- Fast configuration of application-specific measurement options
- Easy configuration and diagnosis thanks to plain-text display
- All languages that can be ordered are available in every device

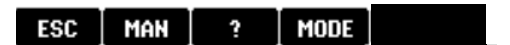
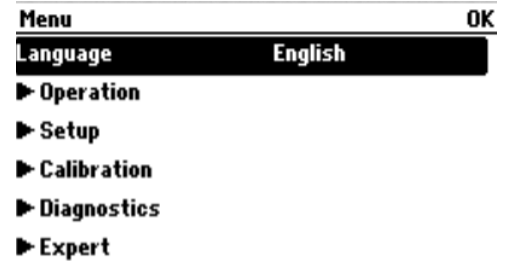

A0024560

A0024443-EN

27 Easy operation

28 Plain-text menu

### Display

Graphic display:

- Resolution: 240 x 160 pixel
- Back light with switch-off function
- Red display background for alarms alerts users to errors
- Transflective display technology for maximum contrast even in bright environments
- User-definable measuring menus mean you can always keep track of the values that are important for your application.

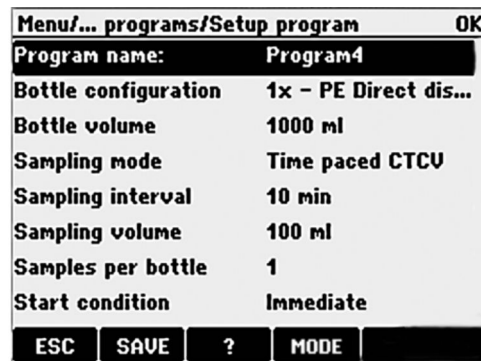

29 Example of program setup

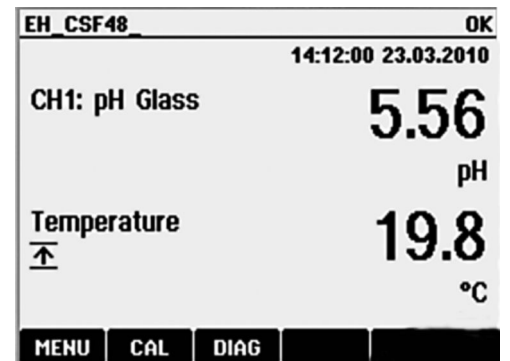

30 Example of measuring menu

### Local operation



A0024469

- LCD, illuminated (with red background in the event of an error)
- 160 x 240 pixels
- 4 operating keys (soft key function) and navigator (jog/shuttle and press/hold function)
- Menu-guided operation

## Remote operation

## Via HART (e.g. via HART modem and FieldCare)

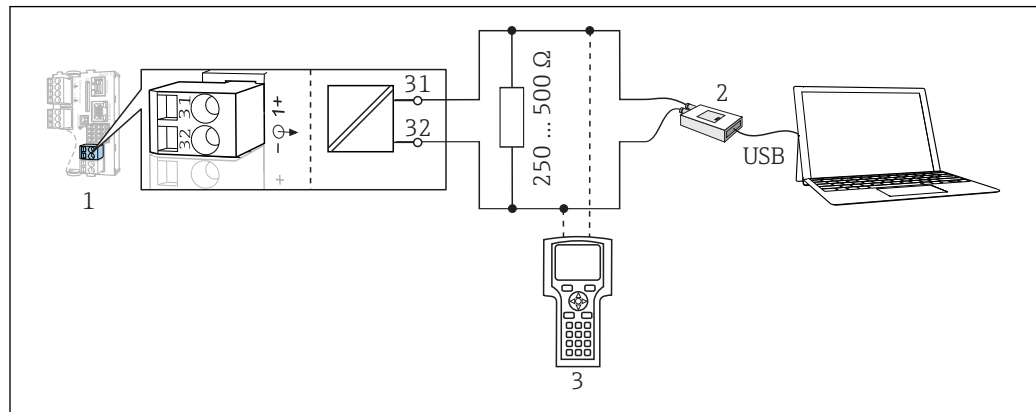

A0039620

## 31 HART using modem

- 1 Device module Base2-E: current output 1 with HART
  - 2 HART modem for connection to PC, e.g. Commubox FXA191 (RS232) or FXA195<sup>1)</sup> (USB)
  - 3 HART handheld terminal
- <sup>1)</sup> Switch position "on" (substitutes the resistor)

## Via PROFIBUS DP

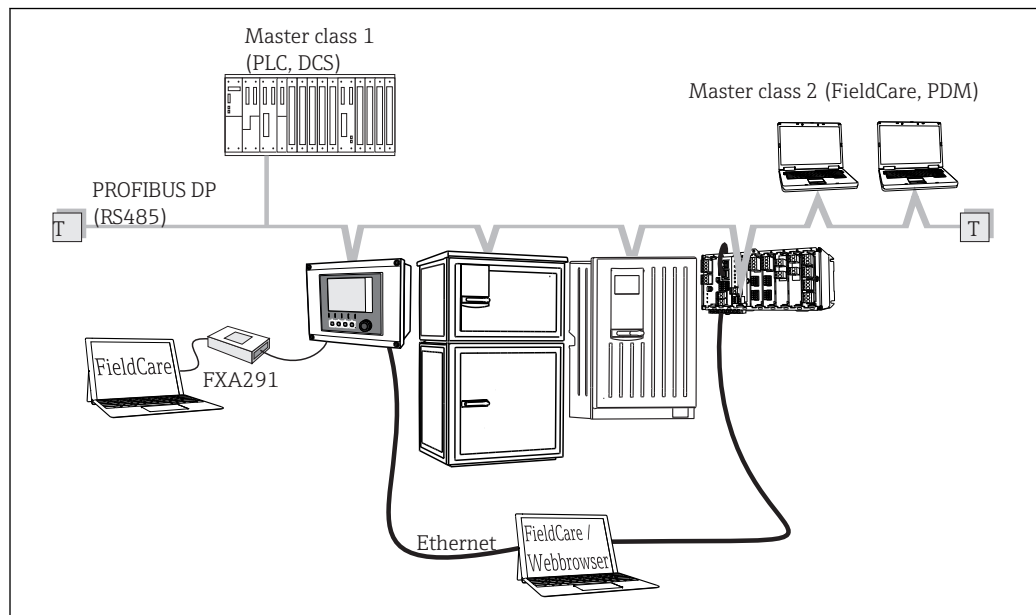

A0039617

## 32 PROFIBUS DP

T Terminating resistor



**Via Modbus RS485**

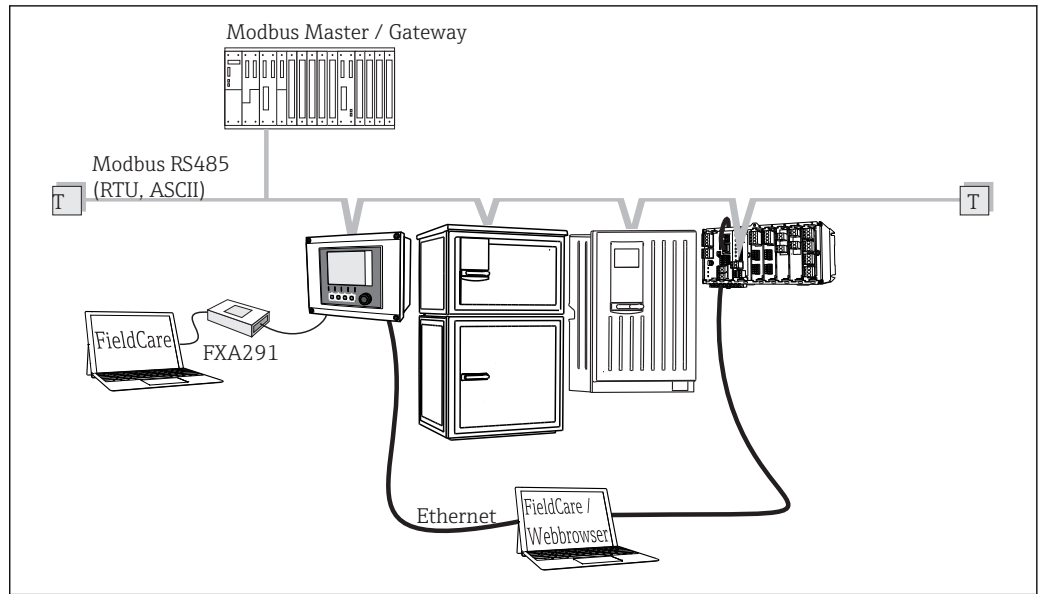

A0039615

33 Modbus RS485

T Terminating resistor

**Via Ethernet: web server/Modbus TCP/PROFINET/EtherNet/IP**

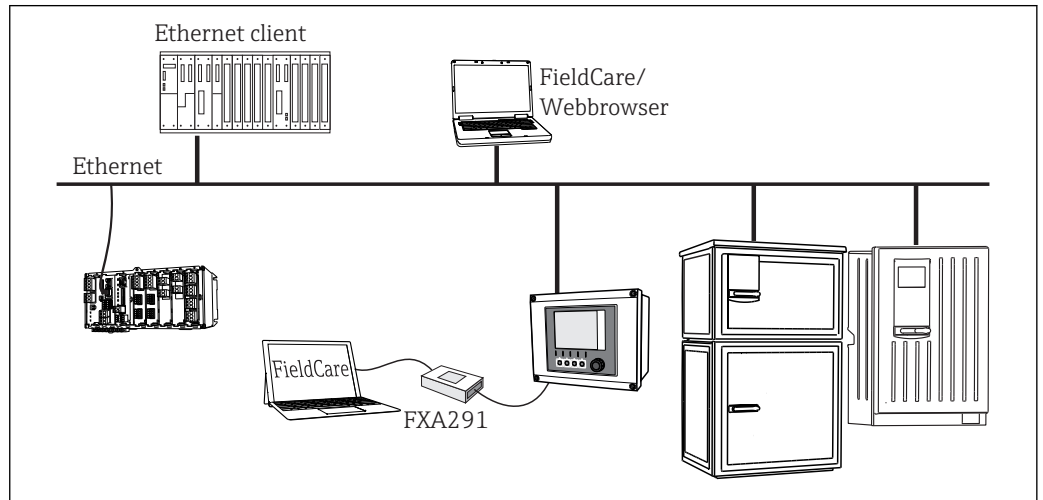

A0039616

34 Modbus TCP or EtherNet/IP or PROFINET

**Communication**

- 1 service interface
- Optionally on front panel
- Commubox FXA291 (accessory) required for communication with the PC

**Software**

**Field Data Manager**

- Standardized user interface under Windows®
- Read-out of internal memory containing the measured flow rate, sample volume taken etc.

**FieldCare**

- Device settings saved in a database
- Configuration

---

## Certificates and approvals

---

<b>CE mark</b>	<b>Declaration of Conformity</b> The product meets the requirements of the harmonized European standards. As such, it complies with the legal specifications of the EU directives. The manufacturer confirms successful testing of the product by affixing to it the <b>CE</b> mark.
<b>MCERTS</b>	The device has been assessed by Sira Certification Service and complies with "MCERTS Performance Standards for Water Monitoring Equipment Part 1, Version 2.1 dated November 2009"; certificate no.: Sira MC100176/02.
<b>cCSAus General purpose</b>	The product meets the requirements in accordance with "Class 8721 05, laboratory equipment, electrical; Class 8721 85, laboratory equipment, electrical, certified to US standards" for indoor use. Certificate no.: 2318018

## Ordering information

---

**Product page** [www.endress.com/CSF48](http://www.endress.com/CSF48)

---

### Product Configurator

On the product page there is a **Configure** button to the right of the product image.

1. Click this button.
  - ↳ The Configurator opens in a separate window.
2. Select all the options to configure the device in line with your requirements.
  - ↳ In this way, you receive a valid and complete order code for the device.
3. Export the order code as a PDF or Excel file. To do so, click the appropriate button on the right above the selection window.



For many products you also have the option of downloading CAD or 2D drawings of the selected product version. Click the **CAD** tab for this and select the desired file type using picklists.

---

### Scope of delivery

The scope of delivery comprises:

- 1 Liquistation CSF48 with:
  - The ordered bottle configuration
  - Optional hardware
- Accessories kit
  - 
  - For peristaltic or vacuum pump:  
Connection nipple for suction line with various angles (straight, 90°), Allen key (for version with vacuum pump only)
- For sampling assembly:
  - 2 or 3 compressed air lines 5 m each, 1 sample line EPDM 13 mm ID 5 m
  - Accessory pack for peristaltic or vacuum pump
  - Accessory pack for order options CSF48-AA31\* and CSF48-AA32\* (preparation for sampling assembly):
- 1 print version of Brief Operating Instructions in the language ordered
- Optional accessories

## Accessories

The following are the most important accessories available at the time this documentation was issued.

- For accessories not listed here, please contact your Service or Sales Center.

Order no.	Bottle tray + bottles + cover
71162811	Bottle tray + 2 x 3.8 liter (1.00 US gal.) glass + cover
71134282	Bottle tray + 6 x 1.8 liter (0.48 US gal.) glass + cover
71111152	Bottle tray + 6 x 3 liter (0.79 US gal.) PE+ cover
71111153	Bottle tray + 12 x 1 liter (0.26 US gal.) glass + cover
71111154	Bottle tray + 12 x 1 liter (0.26 US gal.) PE + cover
71111155	Bottle tray + 12 x 2 liter (0.53 US gal.) PE wedge-shaped bottle + cover
71111156	Bottle tray + 24 x 1 liter (0.26 US gal.) PE wedge-shaped bottle + cover
71111157	Bottle tray + 12 x 1 liter (0.26 US gal.) + 6 x 2 liter (0.53 US gal.) PE wedge-shaped bottle + cover
71185981	Bottle tray + 12 x 2 liter (0.53 US gal.) square PE + cover
71449838	Bottle tray 12x1L / 6x3L / 6x1.8L

Order no.	Distributor plate; centering plate
71111158	Distributor plate for 2 x 6 bottles
71111159	Distributor plate for 2 x 12 bottles
71111160	Distributor plate for 1-2 + 12 bottles
71111161	Distributor plate for 1-2 + 12 bottles
71111162	Distributor plate for 6 + 12 bottles
71185983	Distributor plate for 2 x 12 bottles, 2 liters, PE
71185984	Distributor plate for 1-2 + 12 bottles, 2 liter, PE
71111163	Centering plate for bottle tray with wedge-shaped bottles
71186013	Centering plate for 4 x 5 liters Schott DURAN GLS 80 bottles

Order no.	Bottles + covers
71111164	1 liter (0.26 US gal.) PE + cover, 24 pcs.
71111165	1 liter (0.26 US gal.) glass + cover, 24 pcs.
71134277	1.8 liter (0.48 US gal.) glass + cover, 6 pcs.
71185985	2 liter (0.53 US gal.) PE, square + cover, 24 pcs.
71111167	3 liter (0.79 US gal.) PE + cover, 12 pcs.
71162812	3.8 liter (1.00 US gal.) glass + cover, 1 pc.
71111169	13 liter (3.43 US gal.) PE + cover, 1 pc.
71146645	17 liter (4.49 US gal.) PE, 1 pc.
71111170	25 liter (5.28 US gal.) PE + cover, 1 pc.
71111172	30 liter (7.92 US gal.) PE + cover, 1 pc.
71111173	60 liter (15.8 US gal.) PE + cover, 1 pc.
71111176	1 liter (0.26 US gal.) PE wedge-shaped bottle + cover, 24 pcs.
71111178	2 liter (0.53 US gal.) PE wedge-shaped bottle + cover, 12 pcs

Order no.	Complete suction line
71111233	Suction line ID 10 mm (3/8"), PVC clear, reinforced fabric, length 10 m (33 ft), suction head V4A
71111234	Suction line ID 10 mm (3/8"), EPDM black, length 10 m (33 ft), suction head V4A
71111235	Suction line ID 13 mm (1/2"), PVC green, reinforced spiral wire, length 10 m (33 ft), suction head V4A
71111236	Suction line ID 13 mm (1/2"), EPDM black, length 10 m (33 ft), suction head V4A
71111237	Suction line ID 16 mm (5/8"), PVC green, reinforced spiral wire, length 10 m (33 ft), suction head V4A
71111238	Suction line ID 16 mm (5/8"), EPDM black, length 10 m (33 ft), suction head V4A
71111239	Suction line ID 19 mm (3/4"), PVC green, reinforced spiral wire, length 10 m (33 ft), suction head V4A
71111240	Suction line ID 19 mm (3/4"), EPDM black, length 10 m (33 ft), suction head V4A

Order no.	Terminated hose: vacuum pump
71111188	Dosing hose to distributor, 2 pcs, material: silicon
71111189	Dosing hose to distributor, 25 pcs, material: silicon

Order no.	Terminated hose: peristaltic pump
71111191	Pump tubing, 2 pcs; material: silicon
71111192	Pump tubing, 25 pcs; material: silicon

Order no.	Retrofit kits
71111195	Kit CSF48: Retrofit kit distribution assembly (distribution arm, distribution drive)
71111196	Kit CSF48: Retrofit kit casters
71111197	Kit CSF48: Retrofit kit stand, V2A; 304(x)
71111198	Kit CSF48: Retrofit kit stand, V4A; 316(x)
71111199	Kit CSF48: Retrofit kit for flow assembly, without stand; with stand cover V2A; 304(x)
71111200	Kit CSF48: Retrofit kit for flow assembly, without stand; with stand cover V4A; 316(x)
71111205	Kit CSF48: Retrofit kit for temperature sensor PT1000
71111206	Kit CSF48: Retrofit kit 1x digital sensor, Memosens protocol + 2x output 0/4-20mA (hardware + software)
71111208	Kit CSF48: Retrofit kit 2x digital sensor, Memosens protocol + 2x output 0/4-20mA (hardware + software)
71111210	Kit CSF48: Retrofit kit 1x to 2x digital sensor, Memosens protocol + 2x output 0/4-20mA (software)
71146969	Kit CSF48: Retrofit kit 2x digital sensor + 2x output 0/4-20mA and extension backplane
71136999	Kit CSF48: Retrofit kit service interface (CDI flange connector, counter nut)
71136885	Kit CSF48: Retrofit kit relay (2x + cable set)
71136101	Kit CSF48: Retrofit kit door stop (2x)
71184459	Kit CSF48: Retrofit kit BASE-E module + backplane extension
71207321	Kit CSF48: Sample distribution 24 x 2 liters
71111053	Kit CM442/CM444/CM448/CSF48/CA80: extension module AOR; 2 x relay, 2 x 0/4 to 20 mA analog output
71125375	Kit CM442/CM444/CM448/CSF48/CA80: extension module 2R; 2 x relay

Order no.	Retrofit kits
71125376	Kit CM442/CM444/CM448/CSF48/CA80: extension module 4R; 4 x relay
71135632	Kit CM442/CM444/CM448/CSF48/CA80: extension module 2AO; 2 x 0/4 to 20 mA analog output
71135633	Kit CM442/CM444/CM448/CSF48/CA80: extension module 4AO; 4 x 0/4 to 20 mA analog output
71135631	Kit CM444/CM448/CSF48: Extension module 2DS; 2 x digital sensor, Memosens
71135634	Kit CM442/CM444/CM448/CSF48/CA80: extension module 485; Ethernet configuration; can be extended to PROFIBUS DP or Modbus RS485 or Modbus TCP. This requires an additional activation code which can be ordered separately (see Communication; software).
71135638	Kit CM444R/CM448R/CSF48/CA80: extension module DIO; 2 x digital input; 2 x digital output; auxiliary power supply for digital output
71135639	Kit CM442/CM444/CM448/CSF48/CA80: extension module 2AI; 2 x 0/4 to 20 mA analog input
71140888	Upgrade kit CM442/CM444/CM448/CSF48; extension module 485; PROFIBUS DP (+ Ethernet configuration)
71140889	Upgrade kit CM442/CM444/CM448/CSF48/CA80; extension module 485; Modbus RS485 (+ Ethernet configuration)
71140890	Upgrade kit CM442/CM444/CM448/CSF48/CA80; extension module 485; Modbus TCP (+ Ethernet configuration)
71219868	Upgrade kit CM442/CM444/CM448/CM442R/CM444R/CM448R/CSF48; extension module 485; EtherNet/IP (+ Ethernet configuration)
71140891	Kit CM444/CM448: Upgrade code for 2 x 0/4 to 20 mA for BASE-E
71107456	Kit CM442/CM444/CM448/CSF48: M12 socket for digital sensors; pre-terminated
71140892	Kit CM442/CM444/CM448/CSF48: M12 socket for PROFIBUS DP/Modbus RS485; B-coded, pre-terminated
71140893	Kit CM442/CM444/CM448/CSF48: M12 socket for Ethernet; D-coded, pre-terminated

Order no.	Communication; software
71110815	SD card, 1 GB, Industrial Flash Drive
51516983	Commubox FXA291 + FieldCare Device Setup
71129799	Field Data Manager software; 1 license, analysis report
71127100	SD card with Liquiline Firmware, 1 GB, Industrial Flash Drive
71128428	Activation code for digital HART communication
71367524	Activation code for Heartbeat Verification and Monitoring
71135635	Activation code for PROFIBUS DP
71135635	Activation code for PROFIBUS DP
71135637	Activation code for Modbus TCP
71219871	Activation code for EtherNet/IP
71211288	Activation code for feedforward control
71211289	Activation code for measuring range switch
71249548	Kit CA80: activation code for 1st digital sensor input
71249555	Kit CA80: activation code for 2nd digital sensor input

**Measuring cable****Memosens data cable CYK10**

- For digital sensors with Memosens technology
- Product Configurator on the product page: [www.endress.com/cyk10](http://www.endress.com/cyk10)



Technical Information TI00118C

**Measuring cable CYK81**

- Unterminated cable for extending sensor cables (e.g. Memosens, CUS31/CUS41)
- 2 x 2 cores, twisted with shielding and PVC sheath (2 x 2 x 0.5 mm<sup>2</sup> + shielding)
- Sold by meter, Order No.: 51502543

---

**Sensors****Glass electrodes****Orbisint CPS11D**

- pH sensor for process technology
- With dirt-repellent PTFE diaphragm
- Product Configurator on the product page: [www.endress.com/cps11d](http://www.endress.com/cps11d)



Technical Information TI00028C

**Memosens CPS31D**

- pH electrode with gel-filled reference system with ceramic diaphragm
- Product Configurator on the product page: [www.endress.com/cps31d](http://www.endress.com/cps31d)



Technical Information TI00030C

**Ceraliquid CPS41D**

- pH electrode with ceramic junction and KCl liquid electrolyte
- Product Configurator on the product page: [www.endress.com/cps41d](http://www.endress.com/cps41d)



Technical Information TI00079C

**Ceragel CPS71D**

- pH electrode with reference system including ion trap
- Product Configurator on the product page: [www.endress.com/cps71d](http://www.endress.com/cps71d)



Technical Information TI00245C

**Orbipore CPS91D**

- pH electrode with open aperture for media with high dirt load
- Product Configurator on the product page: [www.endress.com/cps91d](http://www.endress.com/cps91d)



Technical Information TI00375C

**Orbipac CPF81D**

- Compact pH sensor for installation or immersion operation
- In industrial water and wastewater
- Product Configurator on the product page: [www.endress.com/cpf81d](http://www.endress.com/cpf81d)



Technical Information TI00191C

**Pfautler electrodes****Ceramax CPS341D**

- pH electrode with pH-sensitive enamel
- Meets highest demands of measuring accuracy, pressure, temperature, sterility and durability
- Product Configurator on the product page: [www.endress.com/cps341d](http://www.endress.com/cps341d)



Technical Information TI00468C

**ORP sensors****Orbisint CPS12D**

- ORP sensor for process technology
- Product Configurator on the product page: [www.endress.com/cps12d](http://www.endress.com/cps12d)



Technical Information TI00367C

**Ceraliquid CPS42D**

- ORP electrode with ceramic junction and KCl liquid electrolyte
- Product Configurator on the product page: [www.endress.com/cps42d](http://www.endress.com/cps42d)



Technical Information TI00373C

**Ceragel CPS72D**

- ORP electrode with reference system including ion trap
- Product Configurator on the product page: [www.endress.com/cps72d](http://www.endress.com/cps72d)



Technical Information TI00374C

**Orbipac CPF82D**

- Compact ORP sensor for installation or immersion operation in process water and wastewater
- Product Configurator on the product page: [www.endress.com/cpf82d](http://www.endress.com/cpf82d)



Technical Information TI00191C

**Orbipore CPS92D**

- ORP electrode with open aperture for media with high dirt load
- Product Configurator on the product page: [www.endress.com/cps92d](http://www.endress.com/cps92d)



Technical Information TI00435C

**pH ISFET sensors****Tophit CPS441D**

- Sterilizable ISFET sensor for low-conductivity media
- Liquid KCl electrolyte
- Product Configurator on the product page: [www.endress.com/cps441d](http://www.endress.com/cps441d)



Technical Information TI00352C

**Tophit CPS471D**

- Sterilizable and autoclavable ISFET sensor for food and pharmaceuticals, process engineering
- Water treatment and biotechnology
- Product Configurator on the product page: [www.endress.com/cps471d](http://www.endress.com/cps471d)



Technical Information TI00283C

**Tophit CPS491D**

- ISFET sensor with open aperture for media with high dirt load
- Product Configurator on the product page: [www.endress.com/cps491d](http://www.endress.com/cps491d)



Technical Information TI00377C

**Conductivity sensors with inductive measurement of conductivity****Indumax CLS50D**

- High-durability inductive conductivity sensor
- For standard and hazardous area applications
- With Memosens technology
- Product Configurator on the product page: [www.endress.com/cls50d](http://www.endress.com/cls50d)



Technical Information TI00182C

**Conductivity sensors with conductive measurement of conductivity****Condumax CLS15D**

- Conductive conductivity sensor
- For pure water, ultrapure water and hazardous area applications
- Product Configurator on the product page: [www.endress.com/CLS15d](http://www.endress.com/CLS15d)



Technical Information TI00109C



#### **Condumax CLS16D**

- Hygienic, conductive conductivity sensor
- For pure water, ultrapure water and Ex applications
- With EHEDG and 3A approval
- Product Configurator on the product page: [www.endress.com/CLS16d](http://www.endress.com/CLS16d)



Technical Information TI00227C

#### **Condumax CLS21D**

- Two-electrode sensor in plug-in head version version
- Product Configurator on the product page: [www.endress.com/CLS21d](http://www.endress.com/CLS21d)



Technical Information TI00085C

#### **Memosens CLS82D**

- Four-electrode sensor
- With Memosens technology
- Product Configurator on the product page: [www.endress.com/cls82d](http://www.endress.com/cls82d)



Technical Information TI01188C

#### **Oxygen sensors**

##### **Oxymax COS22D**

- Sterilizable sensor for dissolved oxygen
- With Memosens technology or as an analog sensor
- Product Configurator on the product page: [www.endress.com/cos22d](http://www.endress.com/cos22d)



Technical Information TI00446C

##### **Oxymax COS51D**

- Amperometric sensor for dissolved oxygen
- With Memosens technology
- Product Configurator on the product page: [www.endress.com/cos51d](http://www.endress.com/cos51d)



Technical Information TI00413C

##### **Oxymax COS61D**

- Optical oxygen sensor for drinking water and industrial water measurement
- Measuring principle: quenching
- With Memosens technology
- Product Configurator on the product page: [www.endress.com/cos61d](http://www.endress.com/cos61d)



Technical Information TI00387C

##### **Memosens COS81D**

- Sterilizable, optical sensor for dissolved oxygen
- With Memosens technology
- Product Configurator on the product page: [www.endress.com/cos81d](http://www.endress.com/cos81d)



Technical Information TI01201C

#### **Chlorine sensors**

##### **CCS142D**

- Membrane-covered amperometric sensor for free chlorine
- Measuring range 0.01 to 20 mg/l
- With Memosens technology
- Product Configurator on the product page: [www.endress.com/ccs142d](http://www.endress.com/ccs142d)



Technical Information TI00419C

**Ion-selective sensors****ISEmax CAS40D**

- Ion selective sensors
- Product Configurator on the product page: [www.endress.com/cas40d](http://www.endress.com/cas40d)



Technical Information TI00491C

**Turbidity sensors****Turbimax CUS51D**

- For nephelometric measurements of turbidity and solids in wastewater
- 4-beam scattered light method
- With Memosens technology
- Product Configurator on the product page: [www.endress.com/cus51d](http://www.endress.com/cus51d)



Technical Information TI00461C

**Turbimax CUS52D**

- Hygienic Memosens sensor for turbidity measurement in drinking water, process water and in utilities
- With Memosens technology
- Product Configurator on the product page: [www.endress.com/cus52d](http://www.endress.com/cus52d)



Technical Information TI01136C

**SAC and nitrate sensors****Viomax CAS51D**

- SAC and nitrate measurement in drinking water and wastewater
- With Memosens technology
- Product Configurator on the product page: [www.endress.com/cas51d](http://www.endress.com/cas51d)



Technical Information TI00459C

**Interface measurement****Turbimax CUS71D**

- Immersion sensor for interface measurement
- Ultrasonic interface sensor
- Product Configurator on the product page: [www.endress.com/cus71d](http://www.endress.com/cus71d)



Technical Information TI00490C

---

[www.addresses.endress.com](http://www.addresses.endress.com)

---