

Technical Information

Liquiline CM442/CM444/CM448

Multiparameter transmitter with a maximum of eight measuring channels based on digital Memosens technology



For monitoring and controlling processes in industry and the environmental sector

Application

- Water and wastewater
- Power stations
- Chemical industry
- Other industrial applications

Your benefits

- Highly flexible:
 - Able to connect up to 8 Memosens sensors
 - Mathematics functions calculate new measured values
 - Digital fieldbuses (HART, PROFIBUS, Modbus, Ethernet/IP) and integrated web server
 - Choice of cleaning function, controller and alarm relay
- Optional digital or analog inputs/outputs
- Maximum process safety thanks to standardized operating concept across all devices in the Liquiline, sampler and analyzer platform
- Fast commissioning thanks to:
 - Memosens: lab-calibrated sensors & hot plug-and-play
 - Preconfigured Liquiline transmitter
 - Easy extension and adaptation
- Minimum inventory:
 - Cross-platform, modular concept (e.g. identical modules irrespective of parameters)
 - Integration into Fieldcare and W@M facilitates effective asset management

Table of contents

| | | | |
|--|-----------|---|-----------|
| Function and system design | 4 | External power supply | 22 |
| Measuring system | 4 | PFM function | 22 |
| Application example | 5 | Auxiliary voltage | 22 |
| Device architecture | 6 | Test voltage | 22 |
| Slot and port assignment | 6 | Cable specification | 22 |
| Order of the modules | 6 | Current outputs, active | 22 |
| Basic rule for hardware upgrades | 6 | Span | 22 |
| Determining the hardware delivery status | 7 | Signal characteristic | 22 |
| Terminal diagram | 7 | Electrical specification | 22 |
| Device configuration using the example of a CM442- **M1A1FO* | 8 | Cable specification | 22 |
| Function diagram CM442 | 9 | Relay outputs | 23 |
| Device configuration using the example of a CM444- **M42A1FA* | 10 | Electrical specification | 23 |
| Function diagram CM444 | 11 | Cable specification | 23 |
| Device configuration using the example of a CM448- **26A1* | 12 | Protocol-specific data | 23 |
| Function diagram CM448 | 13 | HART | 23 |
| Communication and data processing | 14 | PROFIBUS DP | 24 |
| Dependability | 14 | Modbus RS485 | 24 |
| Reliability | 14 | Modbus TCP | 24 |
| Maintainability | 16 | EtherNet/IP | 24 |
| Safety | 19 | Web server | 25 |
| Input | 20 | Power supply | 25 |
| Measured variables | 20 | Supply voltage | 25 |
| Measuring ranges | 20 | Power consumption | 25 |
| Types of input | 20 | Fuse | 26 |
| Input signal | 20 | Overvoltage protection | 26 |
| Cable specification | 20 | Cable entries | 26 |
| Digital inputs, passive | 20 | Cable specification | 26 |
| Electrical specification | 20 | Electrical connection | 27 |
| Span | 20 | Connecting optional modules | 29 |
| Nominal input current | 20 | Protective ground connection | 31 |
| PFM function | 20 | Sensor connection | 31 |
| Test voltage | 20 | Performance characteristics | 33 |
| Cable specification | 20 | Response time | 33 |
| Current input, passive | 20 | Reference temperature | 33 |
| Span | 20 | Measured error for sensor inputs | 33 |
| Signal characteristic | 20 | Measured error for current inputs and outputs | 33 |
| Internal resistance | 20 | Frequency tolerance of digital inputs and outputs | 33 |
| Test voltage | 20 | Resolution of current inputs and outputs | 33 |
| Output | 21 | Repeatability | 33 |
| Output signal | 21 | Installation | 34 |
| Signal on alarm | 22 | Installation conditions | 34 |
| Load | 22 | Installation | 35 |
| Linearization/transmission behavior | 22 | Environment | 36 |
| Digital outputs, passive | 22 | Ambient temperature range | 36 |
| Electrical specification | 22 | Storage temperature | 37 |
| | | Humidity | 37 |
| | | Degree of protection | 37 |
| | | Vibration resistance | 37 |
| | | Electromagnetic compatibility | 37 |
| | | Electrical safety | 37 |

| | |
|--|-----------|
| Degree of contamination | 37 |
| Pressure compensation to environment | 38 |
| Mechanical construction | 38 |
| Dimensions | 38 |
| Weight | 38 |
| Materials | 38 |
| Operability | 39 |
| display | 39 |
| Operating concept | 39 |
| Local operation | 39 |
| Remote operation | 40 |
| Language packages | 41 |
| Certificates and approvals | 42 |
| CE mark | 42 |
| EAC | 42 |
| cCSAus | 42 |
| MCERTS | 42 |
| Ordering information | 42 |
| Product page | 42 |
| Product Configurator | 42 |
| Scope of delivery | 43 |
| Accessories | 43 |
| Protective cover | 43 |
| Post mounting kit | 43 |
| Measuring cable | 43 |
| Sensors | 43 |
| Additional functionality | 47 |
| Software | 49 |
| Other accessories | 50 |

Function and system design

Measuring system

The overview shows examples of measuring systems. Other sensors and assemblies can be ordered for conditions specific to your application (www.endress.com/products).

Measuring point

A complete measuring system comprises:

- Transmitter Liquiline
- Sensors with Memosens technology
- Assemblies to suit the sensors used
- Post or rail mounting (optional)
- Weather protection cover (optional)

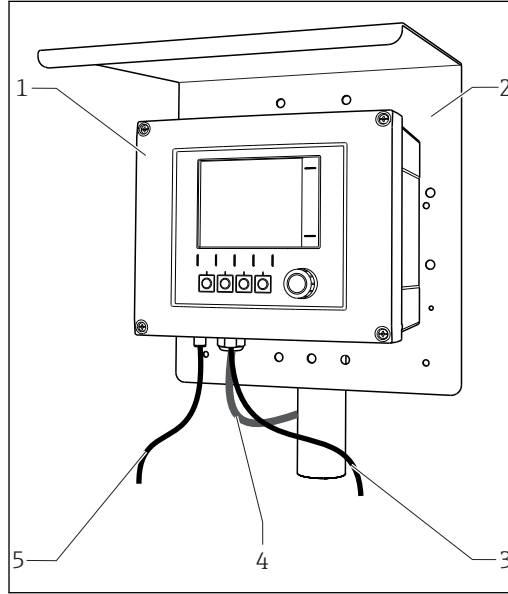

1 Measuring system (e.g. two-channel device)

- 1 Liquiline
- 2 Weather protection cover CYY101 (optional)
- 3, 5 Sensor cable CYK10 or fixed cable
- 4 Power supply cable (to be provided by the customer)

Nitrate and SAC

Nitrate in wastewater

- Sensor CAS51D-**A2 with fixed cable
- Dipfit CYA112 immersion assembly
- Holder CYH112

SAC in the wastewater treatment outlet

- Sensor CAS51D-**2C2 with fixed cable
- Dipfit CYA112 immersion assembly
- Holder CYH112

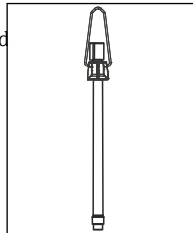

Disinfection

Free available chlorine (and pH) in drinking water

- Sensor CCS142D
- Sensor CPS11D
- Measuring cable CYK10
- Flow assembly CCA250

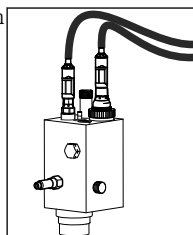

pH value or ORP

pH measurement in drinking water (→ Fig.)

- Retractable assembly Cleanfit CPA871
- Sensor Orbisint CPS11D
- Measuring cable CYK10

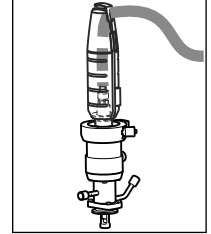

ORP in drinking water

- Dipfit CYA112 immersion assembly
- Sensor Orbisint CPS12D
- Measuring cable CYK10

Conductivity

Inductive conductivity measurement in wastewater treatment

- Sensor Indumax CLS50D
- Sensor fixed cable

Conductive conductivity measurement in power plant cooling water

- Sensor Condumax CLS15D
- Measuring cable CYK10

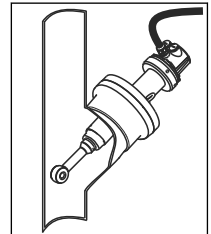

Oxygen

Oxygen in aeration basins

- Dipfit CYA112 immersion assembly
- Holder CYH112
- Sensor
 - COS61D (optical) with fixed cable (→ Fig.)
 - COS51D (amperometric), cable CYK10

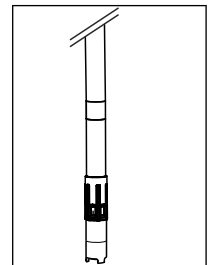

Turbidity and interface

Turbidity in industrial water

- Sensor Turbimax CUS51D with fixed cable (→ Fig.)
- Assembly Flowfit CUA250
- Spray head CUR3 (optional)

Interface in the primary clarifier

- Sensor Turbimax CUS71D
- Assembly CYA112
- Holder CYH112

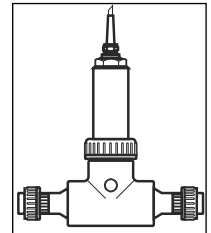

Ion-selective electrodes

Ammonium and nitrate measurement in the aeration basin

- Sensor CAS40D with fixed cable
- Holder CYH112

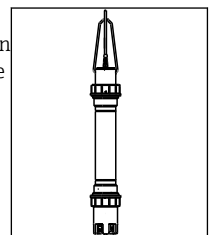

i If mounting outdoors, always use the weather protection cover (see "Accessories") to protect the transmitter against weather conditions.

Application example

Measuring point at wastewater treatment plant outlet (open channel)

- Transmitter CM444-AAM44A0FF with:
 - 4x Memosens, Modbus TCP, 4 x relays for cleaning/limit value, 2 x analog current input
- pH and temperature with CPS11D, item 1, (www.endress.com/cps11d)
- Turbidity with CUS51D, item 2, (www.endress.com/cus51d)
- Nitrate with CAS51D, item 3, (www.endress.com/cas51d)
- Spectral absorption coefficient with CAS51D, item 4, (www.endress.com/cas51d)
- Flow from external measurement via current input
- Assembly holder CYH112 with assemblies CYA112 (www.endress.com/cyh112)

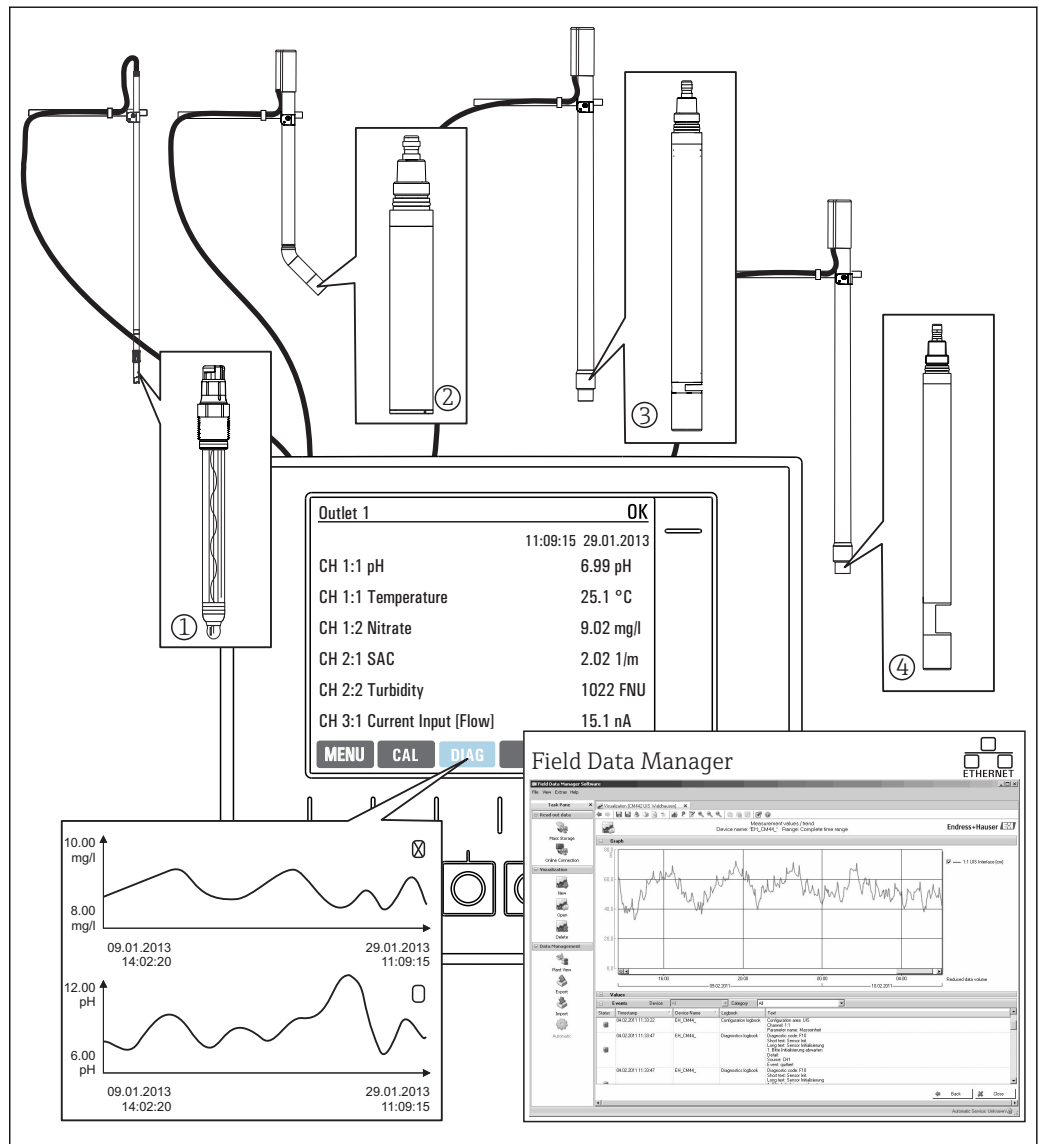

2 Measuring point at wastewater treatment plant outlet

Data retention

- Storage of all measured values, incl. values of external sources, in the non-volatile memory (data logbook)
- Data called up on site via user-defined measuring menu and load curve display of the data logbook
- Transmission of data by ethernet, CDI interface or SD card and storage in a tamper-proof database (Field Data Manager)
- Data export to csv file (for Microsoft Excel)

Device architecture

Slot and port assignment

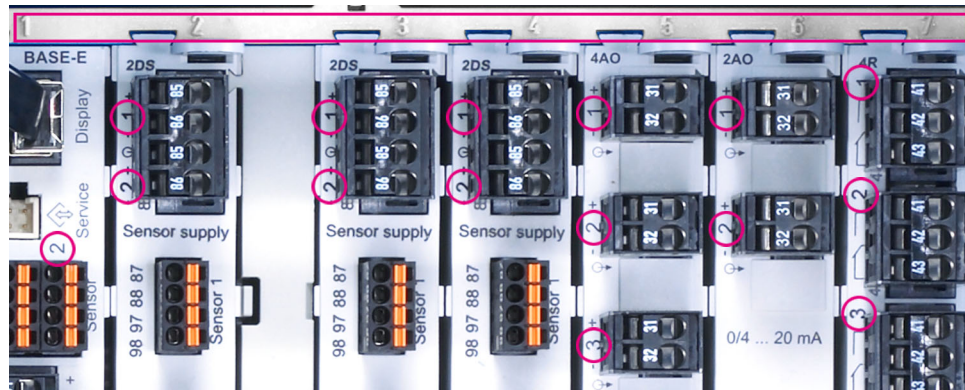
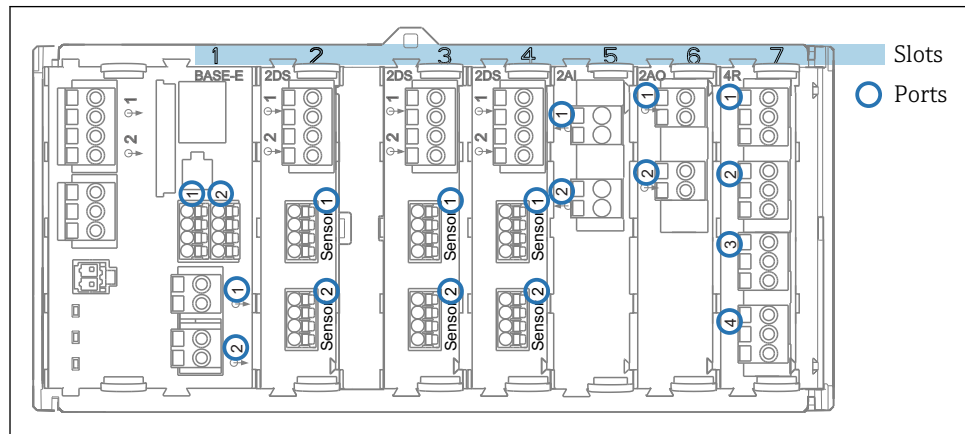

3 Slot and port assignment of the hardware modules

| Outlet 1 | OK | Port Slot |
|-------------------------|-----------------|-----------|
| CH1: 1:1 pH Glass | ATC 6.95 pH | |
| CH2: 1:2 TU/TS | 500.0 g/l | |
| CH3: 5:1 SAC | 500.0 1/m | |
| CH4: 5:2 Cond i | ATC 2.62 mS/cm | |
| CH5: 6:1 Chlorine | 28.33 mg/l | |
| CH6: 6:2 Redox | ± 51 mV | |
| CH7: 7:1 Oxygen (am...) | 32.36 mg/l | |
| CH8: 7:2 Cond c | ATC 131.1 µS/cm | |

4 Slot and port assignment on the display

- Inputs are assigned to measuring channels in the ascending order of the slots and ports. Adjacent example: "CH1: 1:1 pH glass" means: Channel 1 (CH1) is slot 1 (basic module) : Port 1 (input 1), pH glass sensor
- Outputs and relays are named according to their function, e.g. "current output", and are displayed with the slot and port numbers in ascending order

Order of the modules

Depending on the version ordered, the device is supplied with a number of electronic modules, which are assigned in a specific sequence in ascending order to slots 0 to 7. If you do not have a particular module, the next moves up automatically:

- The basic module (which is always present) always occupies slots 0 and 1
- Fieldbus module 485 or Ethernet module ETH (only one of the two modules can be used)
- Memosens input module 2DS (DS = digital sensor)
- Extension module for digital inputs and outputs DIO (DIO = digital input and output)
- Current input module 2AI (AI = analog input)
- Current output module 4AO or 2AO (AO = analog output)
- Relay modules AOR, 4R or 2R (AOR = analog output + relay, R = relay)

i Modules with 4 ports are connected before modules of the same type with 2 ports.

Basic rule for hardware upgrades

- i** Please note the following if upgrading the device:
- The sum of all current inputs and outputs may not exceed 8!
 - A maximum of two "DIO" modules may be used.

Determining the hardware delivery status

You must be aware of the type of modules and the number of them supplied with the device you have ordered to determine the delivery status of your Liquiline.

- Basic module
One basic module in all versions. Always occupies slots 0 and 1.
- Fieldbus module
Optional, and only one fieldbus module is possible.
- Input modules
 - Must be clearly assigned to the number of optional inputs ordered.
 - Examples:
 - 2 current inputs = module 2AI
 - 4 Memosens inputs = 2 inputs with basic module + module 2DS with 2 further inputs
- Current outputs and relays
Various module combinations can exist.
The following table will help you determine which modules your device has, depending on the type and number of outputs.

| Current outputs | Relays | | |
|-----------------|-------------------|----------------------------|----------------------------|
| | 0 | 2 | 4 |
| 2 | - | 1 x 2R | 1 x 4R |
| 4 | 1 x 2AO | 1 x AOR | 1 x 2AO + 1 x 4R |
| 6 | 1 x 4AO | 1 x 4AO + 1 x 2R | 1 x 4AO + 1 x 4R |
| 8 | 1 x 4AO + 1 x 2AO | 1 x 4AO + 1 x 2AO + 1 x 2R | 1 x 4AO + 1 x 2AO + 1 x 4R |

- ▶ Sum up the number of modules and sort them according to the specified sequence → 6.
- ↳ This will give you the slot assignment for your device.

Terminal diagram

 The unique terminal name is derived from:
Slot no. : Port no. : Terminal

Example, NO contact of a relay

Device with 4 inputs for digital sensors, 4 current outputs and 4 relays

- Base module BASE-E (contains 2 sensor inputs, 2 current outputs)
- 2DS module (2 sensor inputs)
- 2AO module (2 current outputs)
- 4R module (4 relays)

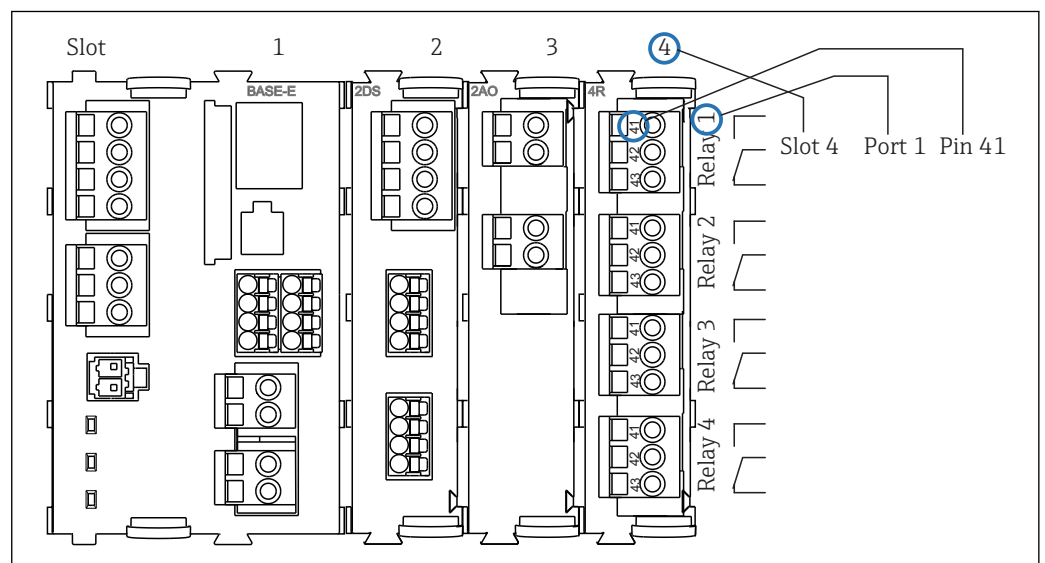

 5 Creating a terminal diagram using the example of the NO contact (terminal 41) of a relay

A0025105

Device configuration using
the example of a CM442-
**M1A1F0*

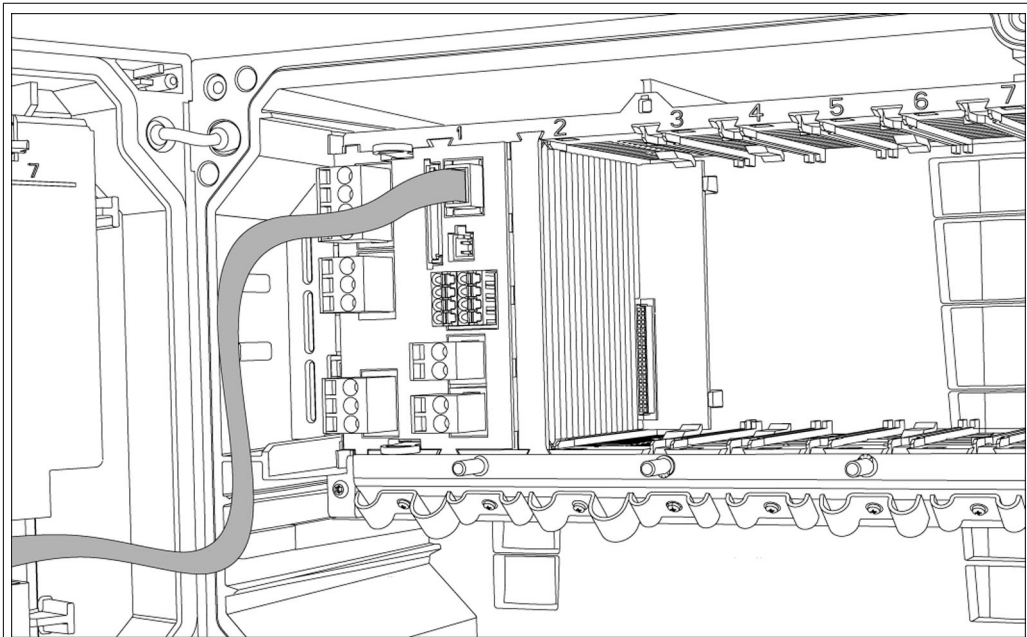

| | |
|---|---|
| Ordered basic device (example) | <ul style="list-style-type: none"> ▪ Order code CM442-**M1A1F0* ▪ Functionality: 1 x Memosens, 2 current outputs without HART |
| Extension options without additional modules | <ul style="list-style-type: none"> ▪ Second Memosens input (71114663) ▪ HART with activation code (71128428) |
| Extension options by using an extension module in free slot 2 | <ul style="list-style-type: none"> ▪ Ethernet/PROFIBUS DP/Modbus with module 485 incl. activation code for the desired communication protocol: <ul style="list-style-type: none"> - PROFIBUS DP (71140888) - Modbus RS485 (71140889) - Modbus TCP (71140890) - EtherNet/IP (71219868) - Only Ethernet without fieldbus (71135634) If fieldbus communication is subsequently required, an activation code is needed for this. ▪ Alternative for Ethernet or Modbus TCP: module ETH  If you retrofit module 485, any existing current outputs are disabled! Alternative: ETH (Ethernet, Modbus TCP only). <p>Additional inputs or outputs, relays:</p> <ul style="list-style-type: none"> - Module 2AI (71135639): 2 current inputs - Module 2AO (71135632): 2 current outputs - Module AOR (71111053): 2 current outputs, 2 relays - Module 2R (71125375) or 4R (71125376): 2 or 4 relays - Module DIO (71135638): 2 digital inputs and 2 digital outputs |
| Device upgrade to CM444 or CM448 | <ul style="list-style-type: none"> ▪ Upgrade kit 71135644 (100 to 230 V AC) or 71211434 (24 V DC) <ul style="list-style-type: none"> - Extension power supply unit and backplane - BASE-E (Memosens inputs same as for base device) - 6 slots for extension modules ▪ Extension options: <ul style="list-style-type: none"> - Second Memosens input (71114663), additional modules same as for CM442 - Up to 8 measuring channels by using an appropriate number of Memosens input modules 2DS (71135631) |
| Basic rule for extensions | The sum of all current inputs and outputs may not exceed 8! |
| Restrictions if using CUS71D sensors for interface measurement | <ul style="list-style-type: none"> ▪ CM442: Only one CUS71D can be connected. The second Memosens input may not be used. ▪ If extending to CM444: Every combination of CUS71D or other sensors is possible. All Memosens inputs (max. 4) can be used. ▪ An extension to CM448 is not advisable as the maximum number of Memosens inputs remains limited to 4. |
| Product Configurator | www.endress.com/cm442 |

Function diagram CM442

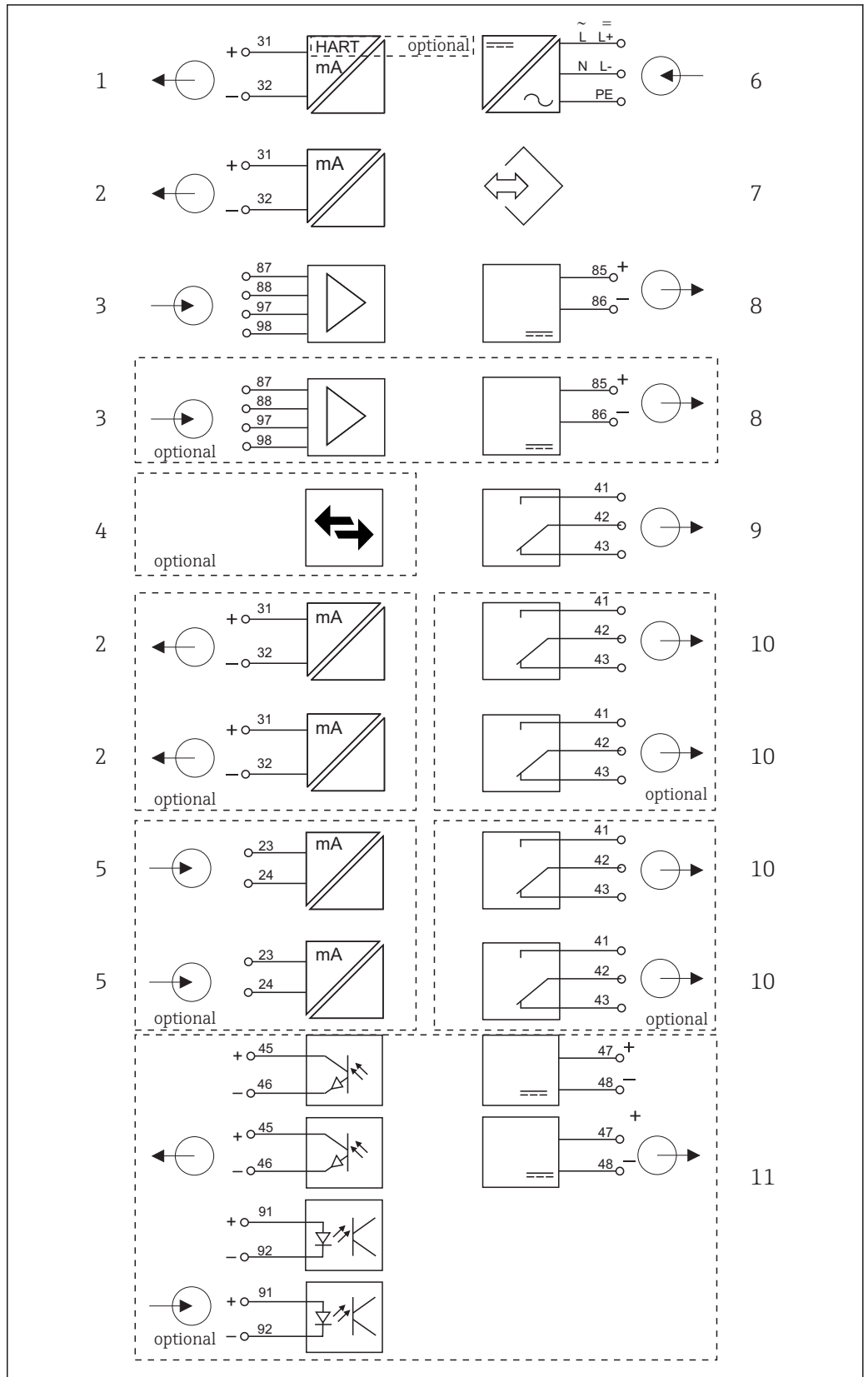

6 Block circuit diagram CM442

- | | | | |
|---|--|----|---|
| 1 | Current output 1:1, + HART (optional) | 6 | Power connection |
| 2 | Current outputs (2 x optional) | 7 | Service interface |
| 3 | 2 x Memosens input (1 x optional) | 8 | Power supply, fixed cable sensors |
| 4 | PROFIBUS DP/Modbus/Ethernet (optional) | 9 | Alarm relay |
| 5 | 2 x current input (optional) | 10 | 2 or 4 x relays (optional) |
| | | 11 | 2 digital inputs and outputs (optional) |

A0015791

Device configuration using the example of a CM444-****M42A1FA***

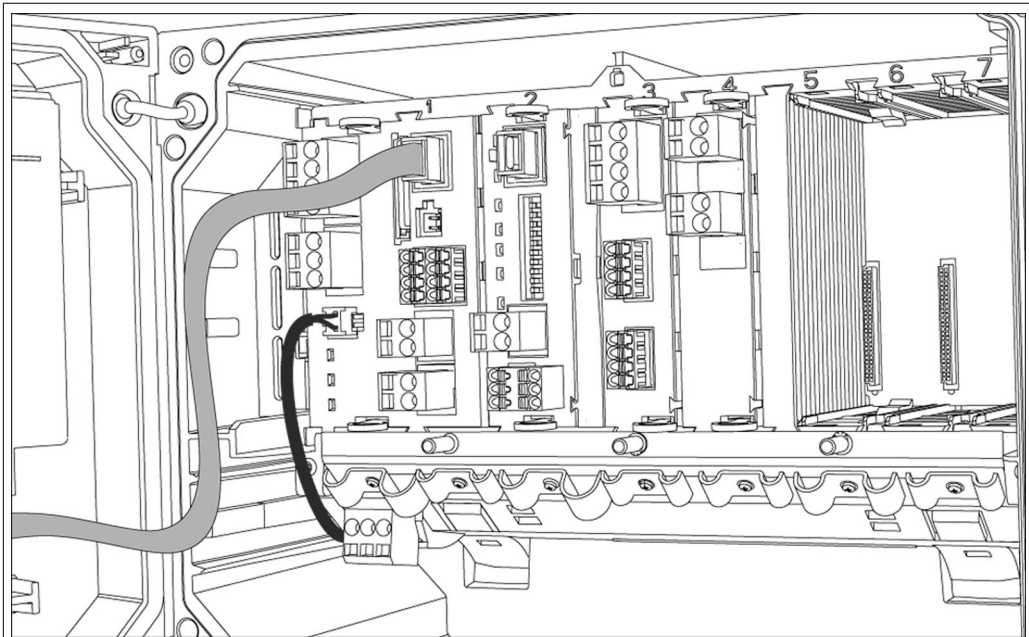

| | |
|--|---|
| <p>Ordered basic device (example)</p> | <ul style="list-style-type: none"> ▪ Order code CM444-**M42A1FA* ▪ Functionality: <ul style="list-style-type: none"> - 4 x Memosens (2 on BASE-E module + 2 on an extension module 2DS) - PROFIBUS communication (module 485) - 2 current outputs without HART (on BASE-E module) - 2 current inputs (module 2AI) <p>3 slots are still free in this example. More or fewer slots can be free in other versions.</p> |
| <p>Extension options without additional modules</p> | <p>None</p> |
| <p>Modification options without additional modules</p> | <ul style="list-style-type: none"> ▪ Communication type changed by entering activation code. This disables the communication type used previously! <ul style="list-style-type: none"> - Modbus RS485 (71140889) - Modbus TCP (71140890) - EtherNet/IP (71219868) ▪ Retrofit to HART by removing module 485 and entering activation code for HART (71128428) |
| <p>Extension options by using extension modules in free slots 5-7</p> | <p>Only the following is possible for the example above: Module 2R (71125375) or 4R (71125376): 2 or 4 relays</p> <p>If extending to eight measuring channels:</p> <ul style="list-style-type: none"> ▪ Module 2DS (71135631): 2 Memosens inputs ▪ Use of the 2 current outputs in the basic module by entering activation code (71140891) <p>Additional inputs or outputs and relays if fieldbus module 485 is removed:</p> <ul style="list-style-type: none"> ▪ Module 2AO (71135632): 2 current outputs ▪ Module AOR (71111053): 2 current outputs, 2 relays ▪ Module 2R (71125375) or 4R (71125376): 2 or 4 relays ▪ Module DIO (71135638): 2 digital inputs and 2 digital outputs <p>i If you replace module 485 with ETH, you can operate up to 6 current outputs in addition to the ETH module's ethernet or Modbus function. Only two current outputs are possible with 485.</p> |
| <p>Basic rule for extensions</p> | <p>The sum of all current inputs and outputs may not exceed 8!</p> |
| <p>Restrictions if using CUS71D sensors for interface measurement</p> | <ul style="list-style-type: none"> ▪ With the CM444, any combination of maximum 4 Memosens sensors is possible. ▪ An extension to CM448 is not advisable as the maximum number of Memosens inputs remains limited to 4 if a CUS71D is used. |
| <p>Product Configurator</p> | <p>www.endress.com/cm444</p> |

Function diagram CM444

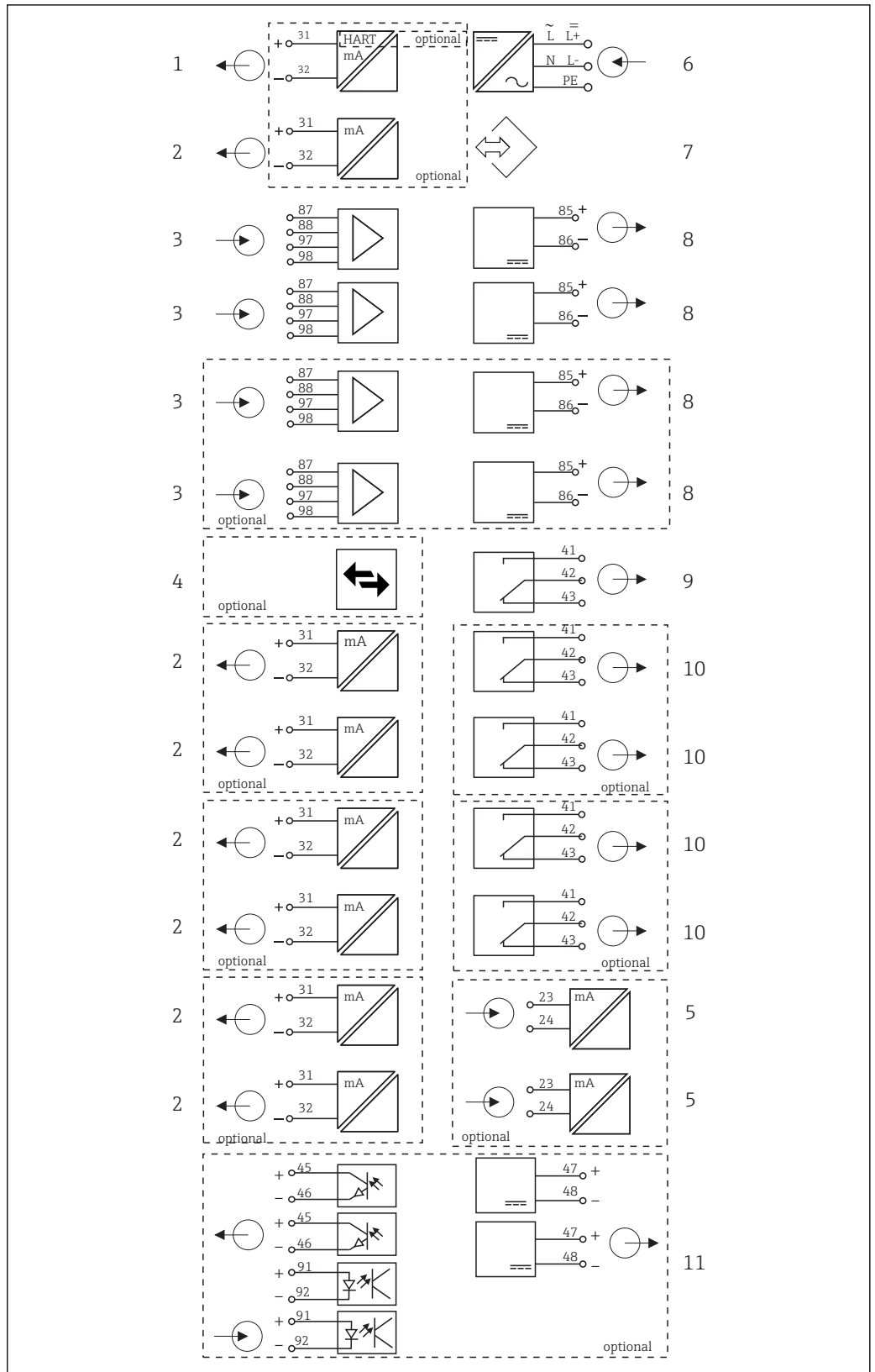



A0015827

7 Block circuit diagram CM444

- | | | | |
|---|--|----|---|
| 1 | Current output 1:1, + HART (both optional) | 6 | Power connection |
| 2 | Max. 7 x current output (optional) | 7 | Service interface |
| 3 | Memosens input (2 x standard + 2 x optional) | 8 | Power supply, fixed cable sensors |
| 4 | PROFIBUS DP/Modbus/Ethernet (optional) | 9 | Alarm relay |
| 5 | 2 x current input (optional) | 10 | 2 or 4 x relays (optional) |
| | | 11 | 2 digital inputs and outputs (optional) |

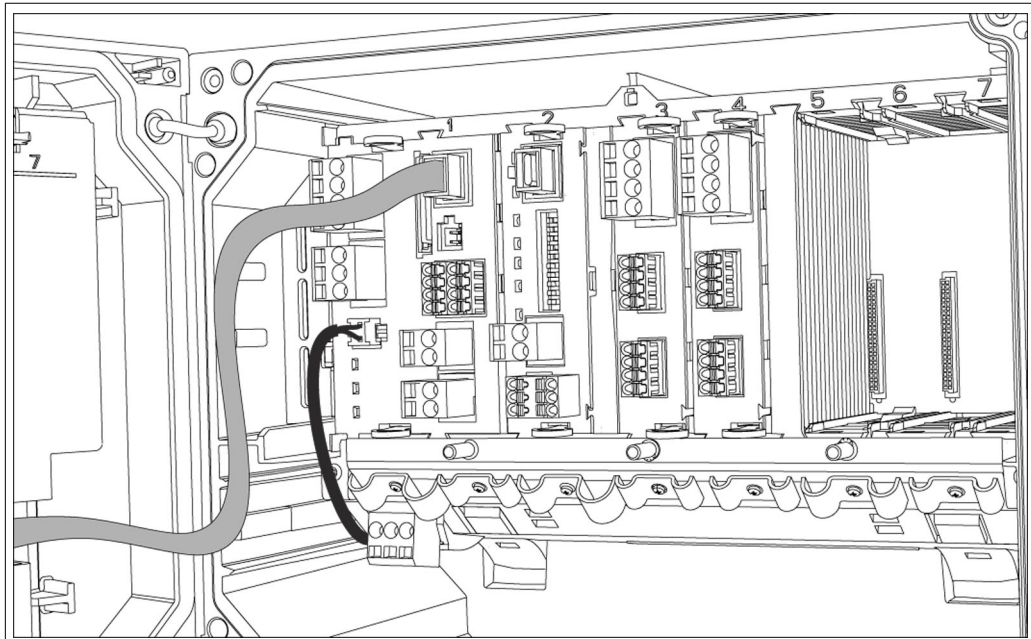
Device configuration using the example of a CM448-**26A1*



| | |
|--|--|
| <p>Ordered basic device (example)</p> | <ul style="list-style-type: none"> ▪ Order code CM448-**26A1* ▪ Functionality: <ul style="list-style-type: none"> - 6 x Memosens (2 on BASE-E module + 2 on two extension modules 2DS) - PROFIBUS communication (module 485) <p>3 slots are still free in this example. More or fewer slots can be free in other versions.</p> |
| <p>Extension options without additional modules</p> | <p>None</p> |
| <p>Modification options without additional modules</p> | <ul style="list-style-type: none"> ▪ Communication type changed by entering activation code. This disables the communication type used previously! <ul style="list-style-type: none"> - Modbus RS485 (71140889) - Modbus TCP (71140890) - EtherNet/IP (71219868) ▪ Retrofit to HART by removing module 485 and entering activation code for HART (71128428) |
| <p>Extension options by using extension modules in free slots 5-7</p> | <p>Only the following is possible for the example above: Module 2R (71125375) or 4R (71125376): 2 or 4 relays</p> <p>If extending to eight measuring channels:</p> <ul style="list-style-type: none"> ▪ Module 2DS (71135631): 2 Memosens inputs ▪ Use of the 2 current outputs in the basic module by entering activation code (71140891) <p>Additional inputs or outputs, relays:</p> <ul style="list-style-type: none"> ▪ Module 2AO (71135632): 2 current outputs ▪ Module 2AI (71135639): 2 current inputs ▪ Module AOR (71111053): 2 current outputs, 2 relays ▪ Module 2R (71125375) or 4R (71125376): 2 or 4 relays ▪ Module DIO (71135638): 2 digital inputs and 2 digital outputs <p> If you replace module 485 with ETH, you can operate up to 6 current outputs in addition to the ETH module's ethernet or Modbus function. Only two current outputs are possible with 485.</p> |
| <p>Basic rule for extensions</p> | <p>The sum of all current inputs and outputs may not exceed 8!</p> |
| <p>Restrictions if using CUS71D sensors for interface measurement</p> | <p>The maximum number of Memosens inputs that can be used is limited to 4! Here, every combination of CUS71D and other Memosens sensors is then possible.</p> |
| <p>Product Configurator</p> | <p>www.endress.com/cm448</p> |

Function diagram CM448

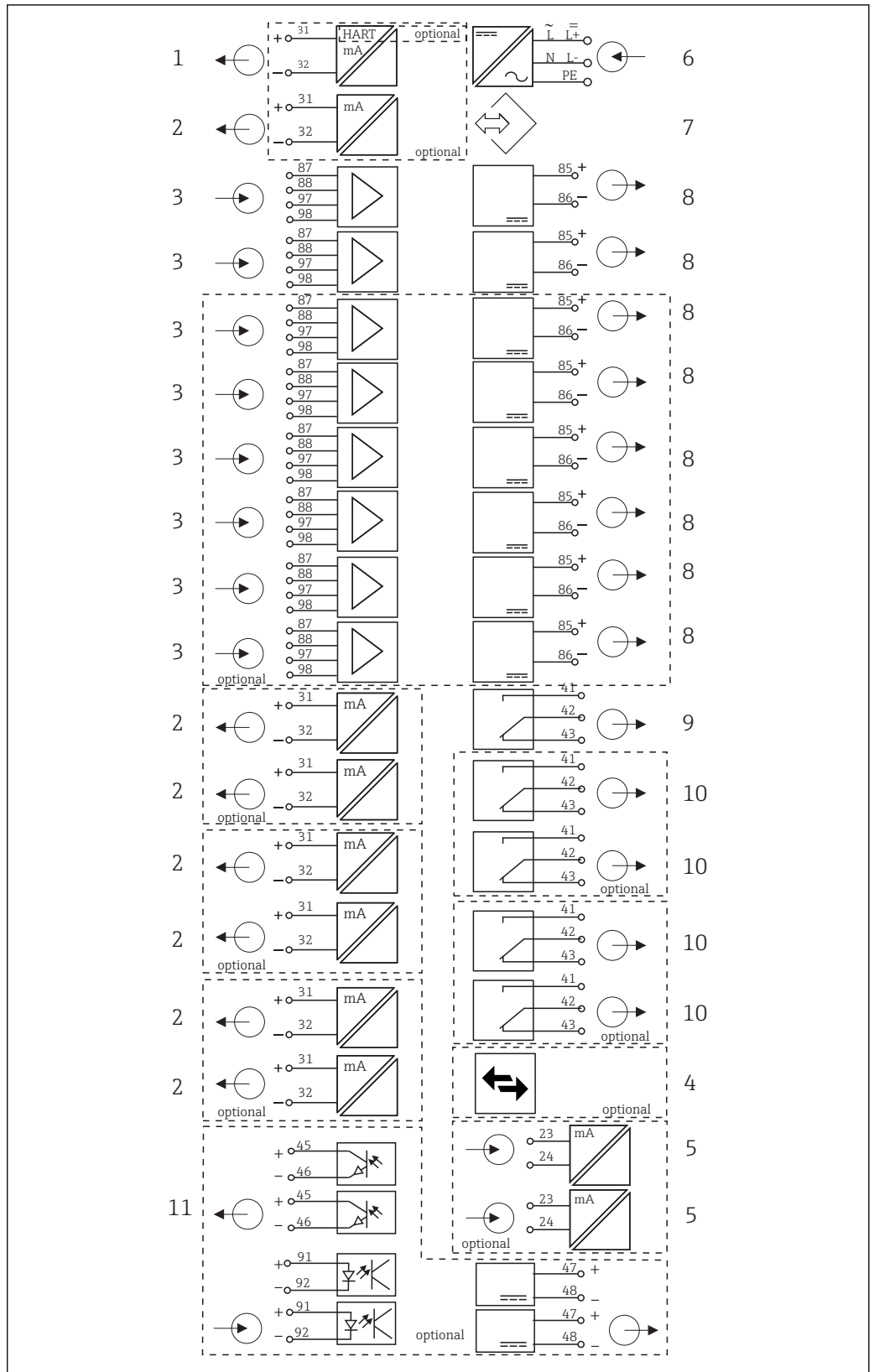

A0015828

8 Function diagram CM448

- | | | | |
|---|--|----|---|
| 1 | Current output 1:1, + HART (both optional) | 7 | Service interface |
| 2 | Max. 7 x current output (optional) | 8 | Power supply, fixed cable sensors |
| 3 | Max 8 x Memosens input (2 x of which are optional) | 9 | Alarm relay |
| 4 | PROFIBUS DP/Modbus/Ethernet (optional) | 10 | 2 or 4 x relays (optional) |
| 5 | 2 x current input (optional) | 11 | 2 digital inputs and outputs (optional) |
| 6 | Power connection | | |

Communication and data processing

Types of communication:

- Fieldbuses
 - HART
 - PROFIBUS DP (Profile 3.02)
 - Modbus TCP or RS485
- EtherNet/IP

 Only one type of Fieldbus communication can ever be active. The last activation code entered decides which bus is used.

The device drivers available make it possible to perform a basic setup and display measured values and diagnostics information via the fieldbus. A full device configuration via the fieldbus is not possible.

Extension module 485 and current outputs

For PROFIBUS DP, Modbus and Ethernet communication protocols:

- CM442
 - Current outputs cannot be used in parallel. Any existing current outputs are deactivated with the installation of 485.
- CM444/CM448
 - A maximum of 2 current outputs can be used in parallel.

Extension module ETH and current outputs

- Communication via Ethernet or EtherNet/IP
- CM442
 - A maximum of 2 current outputs can be used in parallel.
- CM444 and CM448
 - A maximum of 6 current outputs can be used in parallel.

Bus termination on the device

- Via slide switch at bus module 485
- Displayed via LED "T" on bus module 485

Dependability

Reliability

Memosens

Memosens makes your measuring point safer and more reliable:

- Non-contact, digital signal transmission enables optimum galvanic isolation
- No contact corrosion
- Completely watertight
- Sensor can be calibrated in a lab, thus increasing the availability of the measuring point in the process
- Intrinsically safe electronics mean operation in hazardous areas is not a problem.
- Predictive maintenance thanks to recording of sensor data, e.g.:
 - Total hours of operation
 - Hours of operation with very high or very low measured values
 - Hours of operation at high temperatures
 - Number of steam sterilizations
 - Sensor condition

Heartbeat diagnostics

- Heartbeat diagnostics screen with graphic indicators for the health of the device and sensor and with a maintenance or (sensor-dependent) calibration timer
- Heartbeat status information on the health of the device and the condition of the sensor
 - ☺: Sensor/device condition or maintenance timer > 20 %; no action is required
 - ☹: Sensor/device condition or maintenance timer > 5 ≤ 20 %, maintenance not yet urgent but should be scheduled
 - 😞: Sensor/device condition or maintenance timer < 5 %, maintenance is recommended
- The Heartbeat sensor condition is the assessment of the calibration results and the sensor diagnostic functions.

An unhappy smiley can be due to the calibration result, the measured value status or to the operating hours limit having been exceeded. These limits can be configured in the sensor setup in a way that adapts the Heartbeat diagnostics to the application.

Heartbeat and NAMUR category

The Heartbeat status indicates the sensor or device condition while the NAMUR categories (F, C, M, S) assess the reliability of the measured value. The two conditions can correlate but do not have to.

■ Example 1

- The number of remaining cleaning cycles for the sensor reaches 20% of the defined maximum number. The Heartbeat symbol changes from ☺ to ☹. The measured value is still reliable so the NAMUR status signal does not change.
- If the maximum number of cleaning cycles is exceeded, the Heartbeat symbol changes from ☹ to ☹. While the measured value can still be reliable, the NAMUR status signal changes to M (maintenance required).

■ Example 2

The sensor breaks. The Heartbeat status changes immediately from ☺ to ☹ and the NAMUR status signal also changes immediately to F (failure).

Heartbeat Monitoring

Sensor data from Memosens sensors are transmitted via the EtherNet/IP and Modbus TCP fieldbus protocols. These data can be used for predictive maintenance, for instance.

Examples include:

- Total hours of operation
- Hours of operation with very high or very low measured values
- Hours of operation at high temperatures
- Number of steam sterilizations
- Sensor identification
- Calibration information



SD EtherNet/IP and Modbus

Heartbeat Verification

Heartbeat Verification makes it possible to verify the correct operation of the measuring device without interrupting the process. This verification can be documented anytime.

Sensor Check System (SCS)

The Sensor Check System (SCS) monitors the high impedance of the pH glass. An alarm is issued if a minimum impedance value is undershot or a maximum impedance is exceeded.

- Glass breakage is the main reason for a drop in high impedance values
- The reasons for increasing impedance values include:
 - Dry sensor
 - Worn pH glass membrane



For the SCS, upper and lower limit values can be enabled or disabled independently of one another.

Process Check System (PCS)

The process check system (PCS) checks the measuring signal for stagnation. An alarm is triggered if the measuring signal does not change over a specific period (several measured values).

The main causes of stagnating measured values are:

- Contaminated sensor, or sensor outside of medium
- Sensor defective
- Process error (e.g. through control system)

Self-monitoring functions

Current inputs are deactivated in the event of overcurrent and reactivated once the overcurrent stops. Board voltages are monitored and the board temperature is also measured.

USP and EP

The limit functions for pharmaceutical water in accordance with USP and EP specifications are implemented in the software for conductivity measurements:

- "Water for Injection" (WFI) as per USP <645> and EP
- "Highly Purified Water" (HPW) as per EP
- "Purified Water" (PW) as per EP

The uncompensated conductivity value and the temperature are measured for the USP/EP limit functions. The measured values are compared against the tables defined in the standards. An alarm is triggered if the limit value is exceeded. Furthermore, it is also possible to configure an early warning alarm that signals undesired operating states before they occur.

ChemocleanPlus

Freely programmable sequence control

- e.g. for automatic sensor cleaning in retractable assemblies for reliable measurement results in processes with a high risk of contamination
- Individual, time-based activation of 4 outputs e.g. relays
- Starting, stopping or pausing of activities via digital input or fieldbus signals e.g. from limit position switches

Maintainability

Modular design

The modular transmitter design means it can be easily adapted to suit your needs:

- Retrofit extension modules for new or extended range of functions, e.g. current outputs, relays and digital communication
- Upgrade to maximum eight-channel measurement
- Optional: M12 sensor connector for connecting any kind of Memosens sensor
- Optional: CDI connector for external access to the service interface (avoids having to unscrew the housing cover)

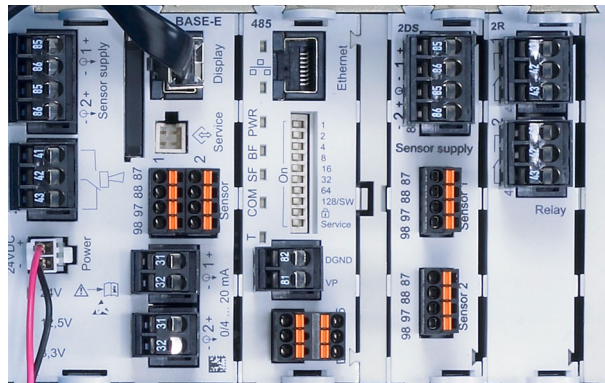

A0016027

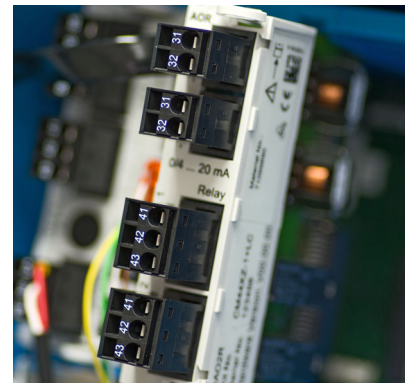

A0012440

9 CM444: example

10 Extension module

Data logger function

- Adjustable scan time: 1 to 3600 s (1 h)
- Data logbooks:
 - Max. 8 data logbooks
 - 150,000 entries per logbook
 - Graphic display (load curves) or numerical list
- Calibration logbook: max. 75 entries
- Hardware version logbook:
 - Hardware configuration and modifications
 - Max. 125 entries
- Version logbook:
 - E.g. software updates
 - Max. 50 entries
- Operation logbook: max. 250 entries
- Diagnostics logbook: max. 250 entries

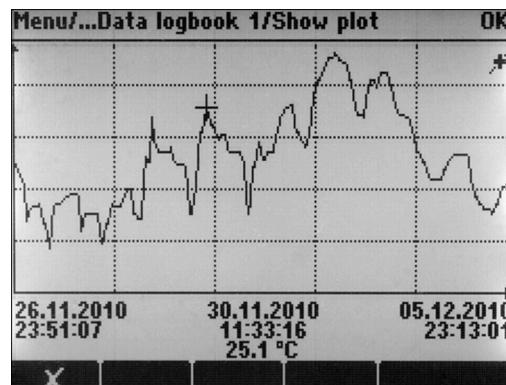

A0015032

11 Data logbook: Graphic display

 Logbooks remain unchanged even after a software update.

SD card

The exchangeable storage medium enables:

- Quick and easy software updates and upgrades
- Data storage of internal device memory (e.g. logbooks)
- Transfer of complete configurations to a device with an identical setup (backup function)
- Transfer of configurations without the TAG and bus address to devices with an identical setup (copy function)
- Saving of screenshots for documentation purposes

Endress+Hauser offers industry-approved SD cards as accessories. These memory cards provide maximum data security and integrity.

Other SD cards up to a maximum weight of 5 g can also be used. However, Endress+Hauser does not accept any responsibility for the data security of such cards.

External signals for device control and for activating external devices

Hardware options, e.g. module "DIO" with 2 digital inputs and 2 digital outputs or fieldbus module "485" enable the following:

- via a digital input signal
 - measuring range switching for conductivity (upgrade code required, see accessories)
 - switching between different calibration datasets in the case of optical sensors
 - an external hold
 - a cleaning interval to be triggered
 - switching on and off a PID controller, e.g. via the proximity switch of the CCA250
 - the use of the input as an "analog input" for pulse-frequency modulation (PFM)
- via a digital output signal
 - the static transmission (similar to a relay) of diagnostic states, point level switch states etc.
 - the dynamic transmission (comparable to a non-wearing "analog output") of PFM signals, e.g. to control dosing pumps.

FieldCare and Field Data Manager

FieldCare

Configuration and asset management software based on FDT/DTM technology

- Complete device configuration when connected via FXA291 and service interface
- Access to a number of configuration parameters and identification, measuring and diagnostic data when connected via HART modem
- Logbooks can be downloaded in CSV format or binary format for "Field Data Manager" software

Field Data Manager

Visualization software and database for measuring, calibration and configuration data

- SQL database which is protected against manipulation
- Functions to import, save and print out logbooks
- Load curves to display measured values

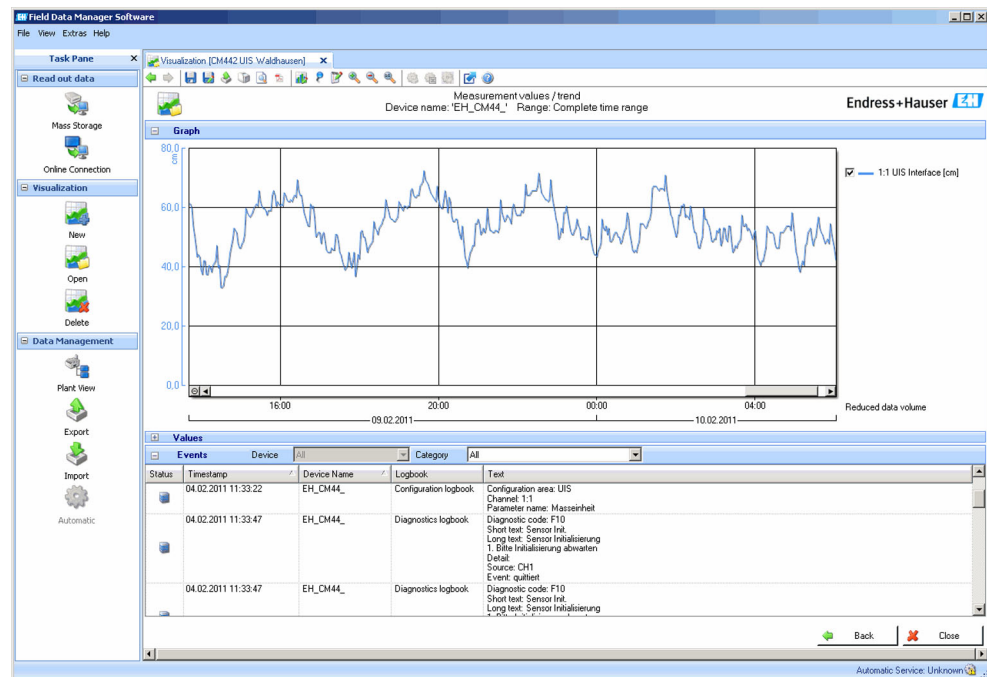

A0016009

12 Field Data Manager: Load curves

Virtual process values (mathematical functions)

In addition to "real" process values, which are provided by connected physical sensors or analog inputs, mathematical functions can be used to calculate a maximum of 6 "virtual" process values.

The "virtual" process values can be:

- Output via a current output or a fieldbus
- Used as a controlled variable
- Assigned as a measured variable to a limit switch
- Used as a measured variable to trigger cleaning
- Displayed in user-defined measuring menus

The following mathematical functions are possible:

- Calculation of pH from two conductivity values according to VGB 405 RL, e. g. in boiler feedwater
- Difference between two measured values from different sources, e. g. for membrane monitoring
- Differential conductivity, e. g. for monitoring the efficiency of ion exchangers
- Degassed conductivity, e. g. for process controls in power plants
- Redundancy for monitoring two or three redundant sensors
- rH calculation based on the measured values of a pH and an ORP sensor
- Calculation of the remaining capacity of a cation exchanger
- Formula editor

Concentration tables

When the device is delivered from the factory, tables are saved in the device that allow inductive conductivity measurements to be converted to concentrations of certain substances. 4 user-defined tables are also possible.

The following factory concentration tables are available:

| | | |
|--------------------------------|----------------------------|-----------------------------|
| NaOH | 0 to 15 % | 0 to 100 °C (32 to 212 °F) |
| NaOH | 25 to 50% | 2 to 80 °C (36 to 176 °F) |
| HCl | 0 to 20 % | 0 to 65 °C (32 to 149 °F) |
| HNO ₃ | 0 to 30 % | 2 to 80 °C (36 to 176 °F) |
| H ₂ SO ₄ | 0.5 to 27 % and 35 to 85 % | 0 to 100 °C (32 to 212 °F) |
| H ₂ SO ₄ | 93 to 100 % | 10 to 115 °C (50 to 239 °F) |
| H ₃ PO ₄ | 0 to 40 % | 2 to 80 °C (36 to 176 °F) |
| NaCl | 0 to 26 % | 2 to 80 °C (36 to 176 °F) |

Safety**Real-time clock**

The device has a real-time clock, which is buffered by a button cell battery if the power supply fails. This ensures that the device continues to keep the correct date and time when it is restarted and that the time stamp for the logbooks is correct.

Data security

All settings, logbooks etc. are stored in a non-volatile memory to ensure that the data are retained even in the event of a disruption to the power supply.

Measuring range switching for conductivity

- Can be used in CIP processes e.g. for safe monitoring of phase separations
- Switching between 4 complete parameter sets:
 - Conductivity operating mode
 - Concentration tables
 - Temperature compensation
 - Output signal range
 - Limit value switch
- Via digital inputs or fieldbus

Measured value compensation for oxygen and conductivity

- Pressure or temperature compensation
- Input signals from external sensors via current input or fieldbus
- Signals from connected temperature sensors

Password protection

Password-protected login

- For remote operation via web server
- For local operation

Process safety

Two independent PID controllers

- One- or two-sided control
- Limit switches
- 4 cleaning programs which can be programmed independently of each other

IT security

Our warranty is valid only if the device is installed and used as described in the Operating Instructions. The device is equipped with security mechanisms to protect it against any inadvertent changes to the settings.

IT security measures, which provide additional protection for the device and associated data transfer, must be implemented by the operators themselves in line with their security standards.

Input

| | |
|----------------------------|--|
| Measured variables | → Documentation of the connected sensor |
| Measuring ranges | → Documentation of the connected sensor |
| Types of input | <ul style="list-style-type: none"> ▪ Digital sensor inputs for sensors with Memosens protocol ▪ Analog current inputs (optional) ▪ Digital inputs (optional) |
| Input signal | Depending on version: <ul style="list-style-type: none"> ▪ Max. 8 x binary sensor signal ▪ 2 x 0/4 to 20 mA (optional), passive, potentially isolated from one another and from the sensor inputs ▪ 0 to 30 V |
| Cable specification | <p>Cable type</p> Memosens data cable CYK10 or sensor fixed cable, each with cable end sleeves or M12 round-pin connector (optional) |
| | <p>Cable length</p> Max. 100 m (330 ft) |

Digital inputs, passive

| | |
|---------------------------------|--|
| Electrical specification | <ul style="list-style-type: none"> ▪ drawing power (passive) ▪ Galvanically isolated |
| Span | <ul style="list-style-type: none"> ▪ High: 11 to 30 V DC ▪ Low: 0 to 5 V DC |
| Nominal input current | max. 8 mA |
| PFM function | Minimum pulse width: 500 µs (1 kHz) |
| Test voltage | 500 V |
| Cable specification | Max. 2.5 mm ² (14 AWG) |

Current input, passive

| | |
|------------------------------|--------------|
| Span | > 0 to 20 mA |
| Signal characteristic | Linear |
| Internal resistance | Non-linear |
| Test voltage | 500 V |

Output

Output signal

Depending on version:

- 2 x 0/4 to 20 mA, active, galvanically isolated from one another and from the sensor circuits
- 4 x 0/4 to 20 mA, active, galvanically isolated from one another and from the sensor circuits
- 6 x 0/4 to 20 mA, active, galvanically isolated from one another and from the sensor circuits
- 8 x 0/4 to 20 mA, active, galvanically isolated from one another and from the sensor circuits
- Optional HART communication (only via current output 1:1)

| HART | |
|-------------------------------|---------------------------------------|
| Signal encoding | FSK \pm 0.5 mA above current signal |
| Data transmission rate | 1200 baud |
| Galvanic isolation | Yes |
| Load (communication resistor) | 250 Ω |

| PROFIBUS DP/RS485 | |
|------------------------|--|
| Signal encoding | EIA/TIA-485, PROFIBUS DP-compliant acc. to IEC 61158 |
| Data transmission rate | 9.6 kBd, 19.2 kBd, 45.45kBd, 93.75 kBd, 187.5 kBd, 500 kBd, 1.5 MBd, 6 MBd, 12 MBd |
| Galvanic isolation | Yes |
| Connectors | Spring terminal (max. 1.5 mm), bridged internally (T-function), optional M12 |
| Bus termination | Internal slide switch with LED display |

| Modbus RS485 | |
|------------------------|--|
| Signal encoding | EIA/TIA-485 |
| Data transmission rate | 2,400, 4,800, 9,600, 19,200, 38,400, 57,600 and 115,200 baud |
| Galvanic isolation | Yes |
| Connectors | Spring terminal (max. 1.5 mm), bridged internally (T-function), optional M12 |
| Bus termination | Internal slide switch with LED display |

| Ethernet and Modbus TCP | |
|-------------------------|--|
| Signal encoding | IEEE 802.3 (Ethernet) |
| Data transmission rate | 10/100 MBd |
| Galvanic isolation | Yes |
| Connection | RJ45, M12 optional |
| IP address | DHCP (default) or configuration via menu |

| EtherNet/IP | |
|------------------------|--|
| Signal encoding | IEEE 802.3 (Ethernet) |
| Data transmission rate | 10/100 MBd |
| Galvanic isolation | Yes |
| Connection | RJ45, M12 optional (D-encoded) |
| IP address | DHCP (default) or configuration via menu |

| | |
|------------------------|--|
| Signal on alarm | Adjustable, as per NAMUR Recommendation NE 43 <ul style="list-style-type: none"> ▪ In measuring range 0 to 20 mA (HART is not available with this measuring range): Failure current from 0 to 23 mA ▪ In measuring range 4 to 20 mA: Failure current from 2.4 to 23 mA ▪ Factory setting for failure current for both measuring ranges: 21.5 mA |
|------------------------|--|

| | |
|-------------|-------------------|
| Load | Max. 500 Ω |
|-------------|-------------------|

| | |
|--|--------|
| Linearization/transmission behavior | Linear |
|--|--------|

Digital outputs, passive

| | |
|---------------------------------|---|
| Electrical specification | <ul style="list-style-type: none"> ▪ Passive ▪ Open collector, max. 30 V, 15 mA ▪ Maximum voltage drop 3 V |
|---------------------------------|---|

| | |
|------------------------------|---|
| External power supply | When using an onsite auxiliary voltage supply and an onsite digital input: Recommended minimum auxiliary voltage = 3 V + V_{IHmin} (V_{IHmin} = minimum input voltage required (high-level input voltage)) |
|------------------------------|---|

| | |
|---------------------|--|
| PFM function | Minimum pulse width: 500 μ s (1 kHz) |
|---------------------|--|

| | |
|--------------------------|--|
| Auxiliary voltage | Electrical specification <ul style="list-style-type: none"> ▪ Galvanically isolated ▪ Unregulated, 24 V DC ▪ Max. 50 mA (per DIO module) |
|--------------------------|--|

| | |
|---------------------|-------|
| Test voltage | 500 V |
|---------------------|-------|

| | |
|----------------------------|-----------------------------------|
| Cable specification | Max. 2.5 mm ² (14 AWG) |
|----------------------------|-----------------------------------|

Current outputs, active

| | |
|-------------|---|
| Span | 0 to 23 mA 2.4 to 23 mA for HART communication |
|-------------|---|

| | |
|------------------------------|--------|
| Signal characteristic | Linear |
|------------------------------|--------|

| | |
|---------------------------------|--|
| Electrical specification | Output voltage Max. 24 V Test voltage 500 V |
|---------------------------------|--|

| | |
|----------------------------|---|
| Cable specification | Cable type Recommended: shielded cable Cable specification Max. 2.5 mm ² (14 AWG) |
|----------------------------|---|

Relay outputs

Electrical specification

Relay types

- 1 single-pin changeover contact (alarm relay)
- 2 or 4 single-pin changeover contacts (optional with extension modules)

Maximum load

- Alarm relay: 0.5 A
- All other relays: 2.0 A

Relay switching capacity

Base module (Alarm relay)

| Switching voltage | Load (max.) | Switching cycles (min.) |
|---------------------------------|-------------|-------------------------|
| 230 V AC, $\cos\Phi = 0.8$ to 1 | 0.1 A | 700,000 |
| | 0.5 A | 450,000 |
| 115 V AC, $\cos\Phi = 0.8$ to 1 | 0.1 A | 1,000,000 |
| | 0.5 A | 650,000 |
| 24 V DC, L/R = 0 to 1 ms | 0.1 A | 500,000 |
| | 0.5 A | 350,000 |

Extension modules

| Switching voltage | Load (max.) | Switching cycles (min.) |
|---------------------------------|-------------|-------------------------|
| 230 V AC, $\cos\Phi = 0.8$ to 1 | 0.1 A | 700,000 |
| | 0.5 A | 450,000 |
| | 2 A | 120,000 |
| 115 V AC, $\cos\Phi = 0.8$ to 1 | 0.1 A | 1,000,000 |
| | 0.5 A | 650,000 |
| | 2 A | 170,000 |
| 24 V DC, L/R = 0 to 1 ms | 0.1 A | 500,000 |
| | 0.5 A | 350,000 |
| | 2 A | 150,000 |

Cable specification

Max. 2.5 mm² (14 AWG)

Protocol-specific data

HART

| | |
|-----------------------------------|--|
| Manufacturer ID | 11 _h |
| Device type | 155D _h |
| Device revision | 001 _h |
| HART version | 7.2 |
| Device description files (DD/DTM) | www.endress.com/hart Device Integration Manager DIM |
| Device variables | 16 user-definable and 16 predefined device variables, dynamic variables PV, SV, TV, QV |
| Supported features | PDM DD, AMS DD, DTM, Field Xpert DD |

PROFIBUS DP

| | |
|--------------------|---|
| Manufacturer ID | 11 _h |
| Device type | 155D _h |
| Profile version | 3.02 |
| GSD files | www.endress.com/profibus Device Integration Manager DIM |
| Output values | 16 AI blocks, 8 DI blocks |
| Input variables | 4 AO blocks, 8 DO blocks |
| Supported features | <ul style="list-style-type: none"> ■ 1 MSCY0 connection (cyclical communication, master class 1 to slave) ■ 1 MSAC1 connection (acyclical communication, master class 1 to slave) ■ 2 MSAC2 connections (acyclical communication, master class 2 to slave) ■ Device lock: The device can be locked using the hardware or software. ■ Addressing using DIL switches or software ■ GSD, PDM DD, DTM |

Modbus RS485

| | |
|--------------------------------------|---|
| Protocol | RTU/ASCII |
| Function codes | 03, 04, 06, 08, 16, 23 |
| Broadcast support for function codes | 06, 16, 23 |
| Output data | 16 measured values (value, unit, status), 8 digital values (value, status) |
| Input data | 4 setpoints (value, unit, status), 8 digital values (value, status), diagnostic information |
| Supported features | Address can be configured using switch or software |

Modbus TCP

| | |
|--------------------------------------|---|
| TCP port | 502 |
| TCP connections | 3 |
| Protocol | TCP |
| Function codes | 03, 04, 06, 08, 16, 23 |
| Broadcast support for function codes | 06, 16, 23 |
| Output data | 16 measured values (value, unit, status), 8 digital values (value, status) |
| Input data | 4 setpoints (value, unit, status), 8 digital values (value, status), diagnostic information |
| Supported features | Address can be configured using DHCP or software |

EtherNet/IP

| | | |
|--------------------|-------------------------------------|-------------|
| Log | EtherNet/IP | |
| ODVA certification | Yes | |
| Device profile | Generic device (product type: 0x2B) | |
| Manufacturer ID | 0x049E _h | |
| Device type ID | 0x109C _h | |
| Polarity | Auto-MIDI-X | |
| Connections | CIP | 12 |
| | I/O | 6 |
| | Explicit message | 6 |
| | Multicast | 3 consumers |
| Minimum RPI | 100 ms (default) | |

| | | |
|--------------------|----------------|--|
| Maximum RPI | 10000 ms | |
| System integration | EtherNet/IP | EDS |
| | Rockwell | Add-on-Profile Level 3, Faceplate for Factory Talk SE |
| IO data | Input (T → O) | Device status and diagnostic message with highest priority Measured values: <ul style="list-style-type: none"> ▪ 16 AI (analog input) + Status + Unit ▪ 8 DI (discrete input) + Status |
| | Output (O → T) | Actuating values: <ul style="list-style-type: none"> ▪ 4 AO (analog output) + status + unit ▪ 8 DO (discrete output) + Status |

Web server

The Web server enables full access to the device configuration, measured values, diagnostic messages, logbooks and service data via standard WiFi/WLAN/LAN/GSM or 3G routers with a user-defined IP address.

| | |
|--------------------|---|
| TCP port | 80 |
| Supported features | <ul style="list-style-type: none"> ▪ Remote-controlled device configuration(1 session) ▪ Save/restore device configuration (via SD card) ▪ Logbook export (file formats: CSV, FDM) ▪ Access to Web server via DTM or Internet Explorer ▪ Login ▪ Web server can be switched off |

Power supply

Supply voltage

CM442

Depending on version:

- 100 to 230 V AC, 50/60 Hz
Maximum permitted fluctuation of mains supply voltage: ± 15 % of nominal voltage
- 24 V AC/DC, 50/60 Hz
Maximum permitted fluctuation of mains supply voltage: + 20/- 15 % of nominal voltage

CM444 and CM448

Depending on the version,:

- 100 to 230 V AC, 50/60 Hz
Maximum permitted fluctuation of mains supply voltage: ± 15 % of nominal voltage
- 24 V DC
Maximum permitted fluctuation of mains supply voltage: + 20/- 15 % of nominal voltage

NOTICE

The device does not have a power switch!

- ▶ Provide a protected circuit breaker in the vicinity of the device at the place of installation.
- ▶ The circuit breaker must be a switch or power switch, and must be labeled as the circuit breaker for the device.
- ▶ At the supply point, the power supply must be isolated from dangerous live cables by double or reinforced insulation in the case of devices with a 24 V supply voltage.

Power consumption

CM442

Depending on supply voltage

- 100 to 230 V AC and 24 V AC:
Max. 55 VA
- 24 V DC:
Max. 22 W

CM444 and CM448

Depending on supply voltage

- 100 to 230 V AC:
Max. 73 VA
- 24 V DC:
Max. 68 W

Fuse Fuse not exchangeable

Overvoltage protection Integrated overvoltage/lightning protection as per EN 61326
Protection category 1 and 3

Cable entries

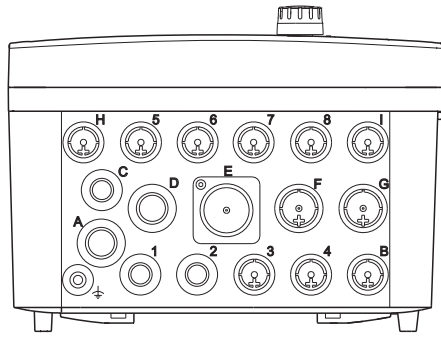
| Identification of the cable entry on housing base | Suitable gland |
|---|---|
| B, C, H, I, 1-8 | M16x1.5 mm/NPT3/8"/G3/8 |
| A, D, F, G | M20x1.5 mm/NPT1/2"/G1/2 |
| E | - |
| ⏏ | M12x1.5 mm |
|  <p style="text-align: right; font-size: small;">A0018025</p> | Recommended assignment 1-8 Sensors 1-8 A Power supply B RS485 In or M12 DP/RS485 C Can be used freely D,F,G Current outputs and inputs, relays H Can be used freely I RS485 Out or M12 Ethernet E Do not use |

Cable specification

| Cable gland | Permitted cable diameter |
|-------------|----------------------------|
| M16x1.5 mm | 4 to 8 mm (0.16 to 0.32") |
| M12x1.5 mm | 2 to 5 mm (0.08 to 0.20") |
| M20x1.5 mm | 6 to 12 mm (0.24 to 0.48") |
| NPT3/8" | 4 to 8 mm (0.16 to 0.32") |
| G3/8 | 4 to 8 mm (0.16 to 0.32") |
| NPT1/2" | 6 to 12 mm (0.24 to 0.48") |
| G1/2 | 7 to 12 mm (0.28 to 0.48") |



Cable glands mounted at the factory are tightened with 2 Nm.

Electrical connection

Basic module

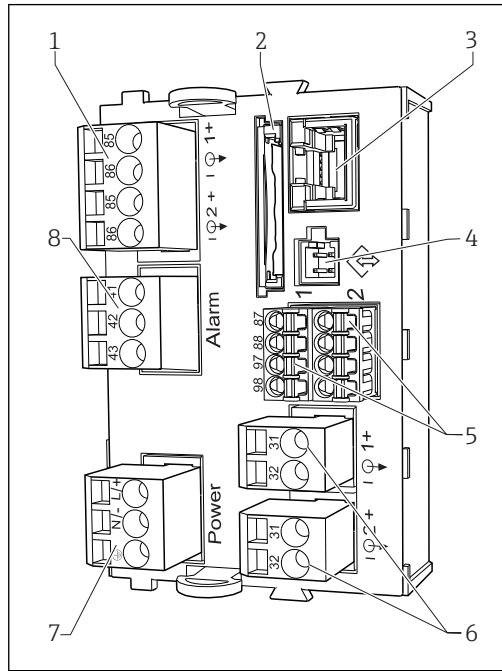

13 Basic module BASE-H or -L (two-channel device)

- 1 Power supply for digital fixed cable sensors with Memosens protocol
- 2 SD card slot
- 3 Slot for display cable ¹⁾
- 4 Service interface
- 5 Connections for 2 Memosens sensors
- 6 Current outputs
- 7 Power connection
- 8 Alarm relay connection

¹⁾ Internal device connection. Do not disconnect the plug!

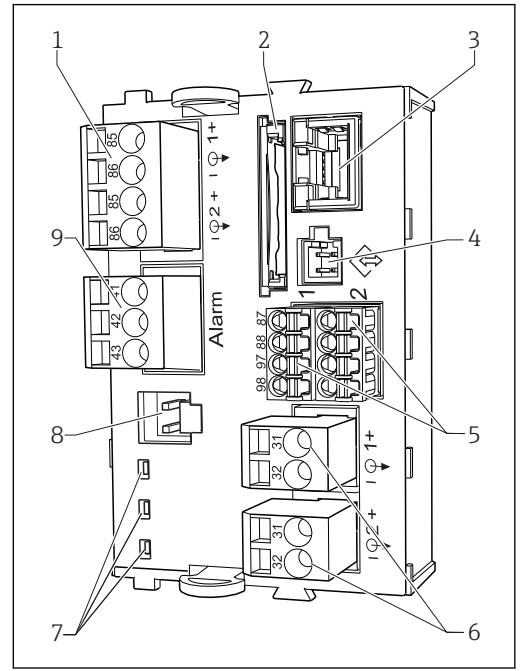

14 Basic module BASE-E (four- and eight-channel device)

- 1 Power supply for digital fixed cable sensors with Memosens protocol
- 2 SD card slot
- 3 Slot for display cable ¹⁾
- 4 Service interface
- 5 Connections for 2 Memosens sensors
- 6 Current outputs
- 7 LEDs
- 8 Socket for internal supply cable ¹⁾
- 9 Alarm relay connection

Connecting supply voltage for CM442

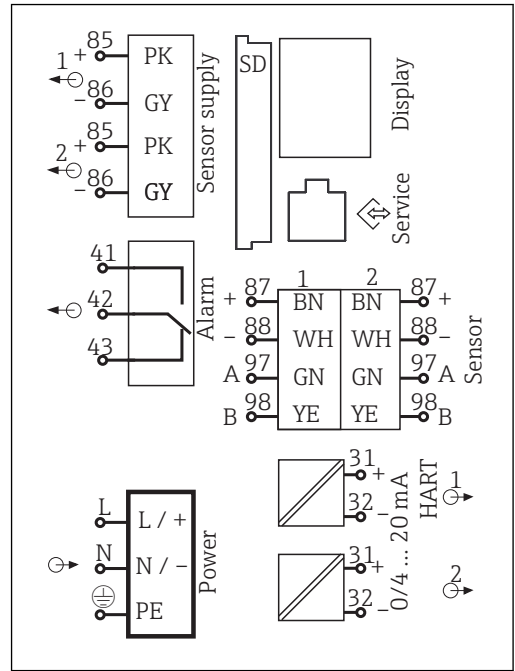
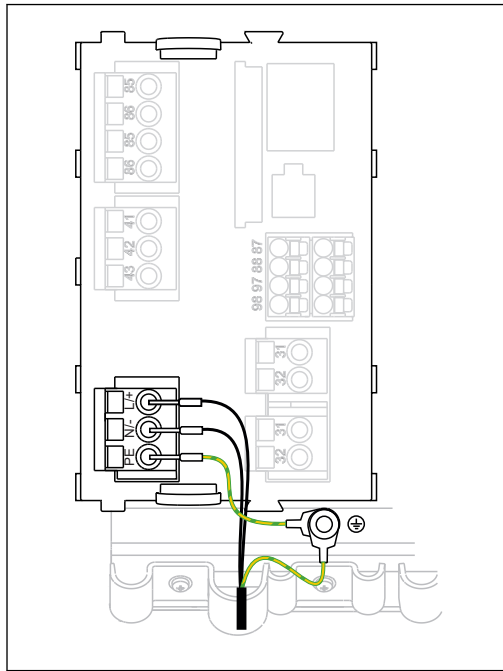

15 Connecting power supply on the BASE-H or -L

16 Overall wiring diagram for BASE-H or -L

H Power unit 100 to 230 VAC
 L Power unit 24 VAC or 24 VDC

Connecting supply voltage for CM444 and CM448

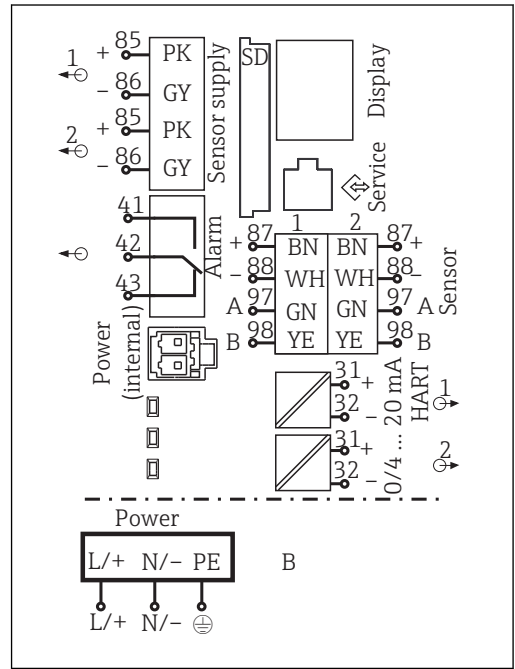
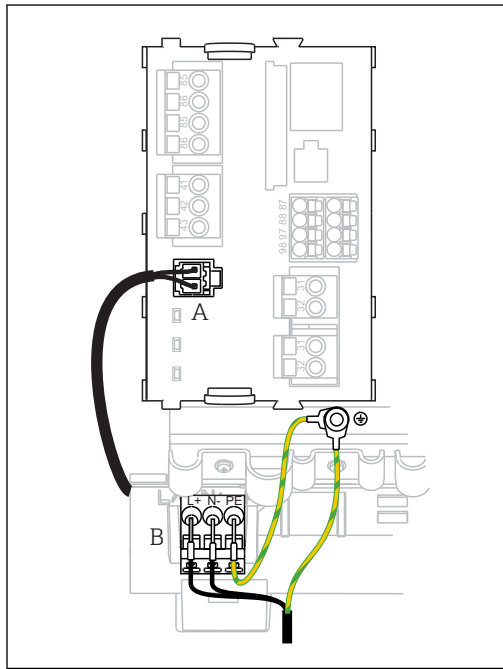

17 Power supply connection on the BASE-E

18 Overall wiring diagram BASE-E and extension power unit (B)

A Internal power supply cable
 B Extension power unit

Connecting optional modules With extension modules you can purchase additional functions for your device.

NOTICE

Unacceptable hardware combinations (due to conflicts in power supply)

Incorrect measurements or total failure of the measuring point as a result of heat build-up or overloading

- ▶ If you are planning to extend your controller, make sure the resulting hardware combination is permitted (Configurator at www.endress.com/CM442 or .../CM444 or .../CM448).
- ▶ Please note that if you are extending CM442 to CM444 or CM448, you must additionally fit an extension power supply unit and an extension backplane. You must then also use basic module BASE-E.
- ▶ Remember that the sum of all current inputs and outputs may not exceed 8.
- ▶ Make sure not to use more than 2 "DIO" modules. More "DIO" modules are not permitted.
- ▶ Please contact your Endress+Hauser sales center should you have any questions.

Overview of all the modules available

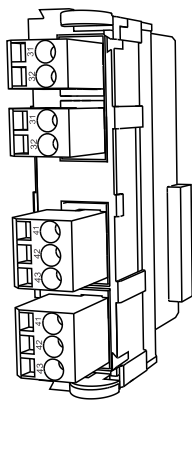
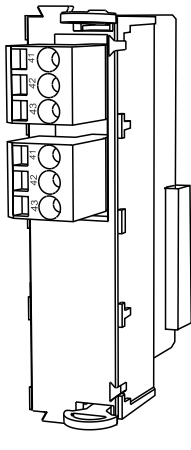
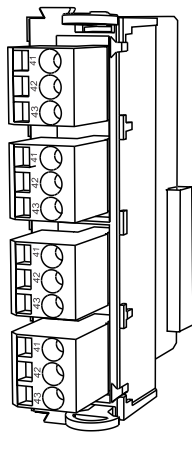
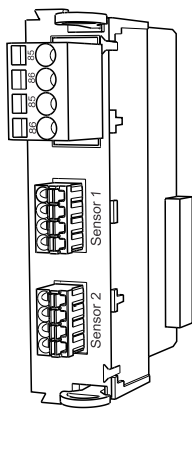
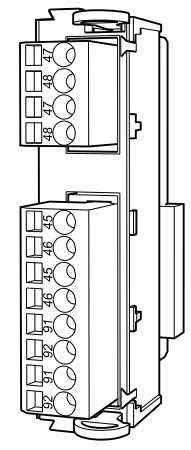
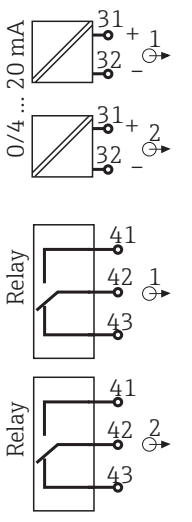
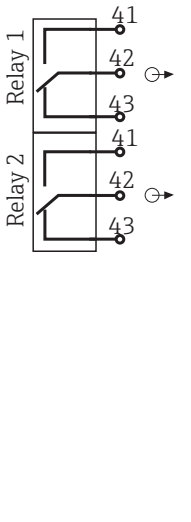
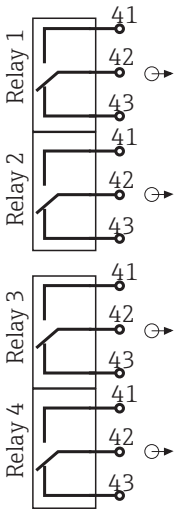
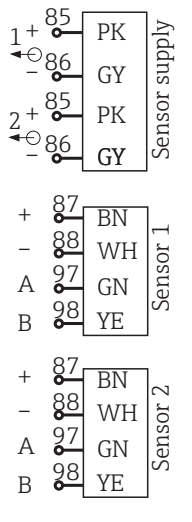
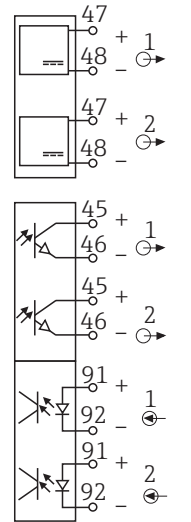
| Module name | | | | |
|---|--|--|---|--|
| AOR | 2R | 4R | 2DS | DIO |
|  |  |  |  |  |
| <ul style="list-style-type: none"> ▪ 2 x 0/4 to 20 mA analog outputs ▪ 2 relays ▪ Order No. 71111053 | <ul style="list-style-type: none"> ▪ 2 relays ▪ Order No. 71125375 | <ul style="list-style-type: none"> ▪ 4 relays ▪ Order No. 71125376 | <ul style="list-style-type: none"> ▪ 2 digital sensor inputs ▪ 2 power supply systems for digital sensors ▪ Order No. 71135631 | <ul style="list-style-type: none"> ▪ 2 digital inputs ▪ 2 digital outputs with auxiliary voltage ▪ Order No. 71135638 |
|  |  |  |  |  |

| Module name | | | | |
|---|---|---|---|--|
| 2AO | 4AO | 2AI | 485 | ETH |
| | | | | |
| <ul style="list-style-type: none"> 2 x 0/4 to 20 mA analog outputs Order No. 71135632 | <ul style="list-style-type: none"> 4 x 0/4 to 20 mA analog outputs Order No. 71135633 | <ul style="list-style-type: none"> 2 x 0/4 to 20mA analog inputs Order No. 71135639 | <ul style="list-style-type: none"> Ethernet (web server or Modbus TCP) 5V power supply for PROFIBUS DP termination RS485 (PROFIBUS DP or Modbus RS485) Order No. 71135634 | <ul style="list-style-type: none"> Web server and Ethernet/IP or Modbus TCP Order No. 71272410 |
| | | | | |

PROFIBUS DP (module 485)

Contacts 95, 96 and 99 are bridged in the connector. This ensures that PROFIBUS communication is not interrupted if the connector is disconnected.

Protective ground connection

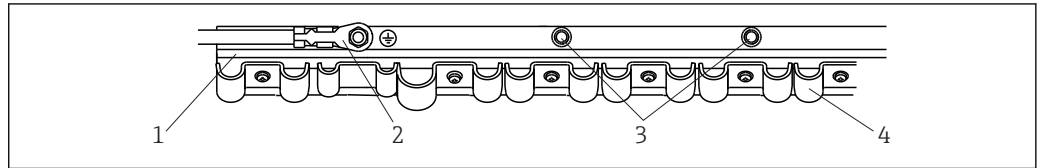

A0025171

▣ 19 Cable mounting rail and associated function

- | | |
|---|---|
| 1 Cable mounting rail | 3 Additional threaded bolts for ground connections |
| 2 Threaded bolt (protective ground connection, central grounding point) | 4 Cable clamps (fixing and grounding the sensor cables) |

Sensor connection

Sensors with Memosens protocol

| Sensor types | Sensor cable | Sensors |
|---|---|---|
| Digital sensors without additional internal power supply | With plug-in connection and inductive signal transmission | <ul style="list-style-type: none"> ▪ pH sensors ▪ ORP sensors ▪ Combined sensors ▪ Oxygen sensors (amperometric and optical) ▪ Conductivity sensors with conductive measurement of conductivity ▪ Chlorine sensors (disinfection) |
| | Fixed cable | Conductivity sensors with inductive measurement of conductivity |
| Digital sensors with additional internal power supply | Fixed cable | <ul style="list-style-type: none"> ▪ Turbidity sensors ▪ Sensors for interface measurement ▪ Sensors for measuring the spectral absorption coefficient (SAC) ▪ Nitrate sensors ▪ Optical oxygen sensors ▪ Ion-sensitive sensors |

The following rule applies if connecting CUS71D sensors:

- CM442
 - Only one CUS71D is possible; an additional sensor is not permitted.
 - The second sensor input may also not be used for another type of sensor.
- CM444
 - No restrictions. All the sensor inputs can be used as required.
- CM448
 - If a CUS71D is connected, the number of sensor inputs that can be used is limited to a maximum of 4.
 - Of these, all 4 inputs can be used for CUS71D sensors.
 - Every combination of CUS71D and other sensors is possible, provided that the total number of connected sensors does not exceed 4.

Types of connection

- Direct connection of sensor cable to terminal connector of the sensor module 2DS or of base module L, H or E (→ ▣ 20 ff.)
- Optional: Sensor cable plug connected to the M12 sensor socket on the underside of the device
With this type of connection, the device is already wired at the factory (→ ▣ 23).

Sensor cable connected directly

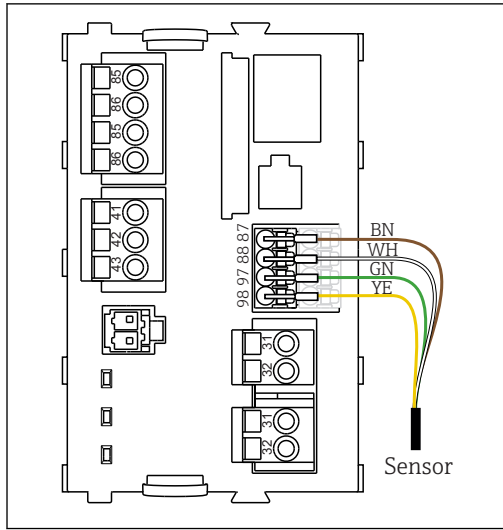

A0023038

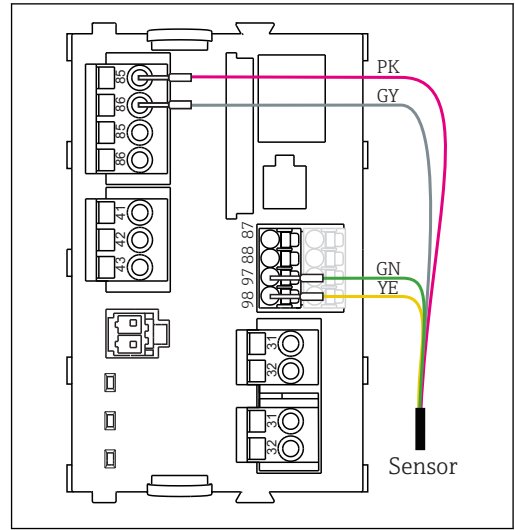

A0023039

20 sensors without additional supply voltage

21 sensors with additional supply voltage

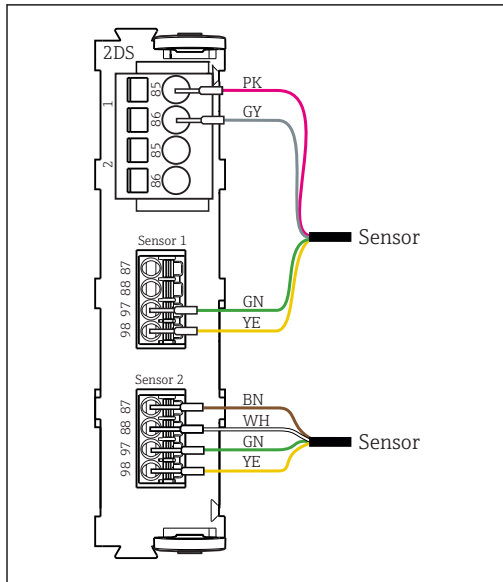

A0033206

22 sensors with and without additional supply voltage at sensor module 2DS

connection via M12 plug-in connection

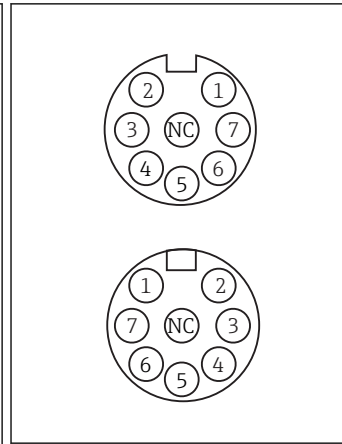
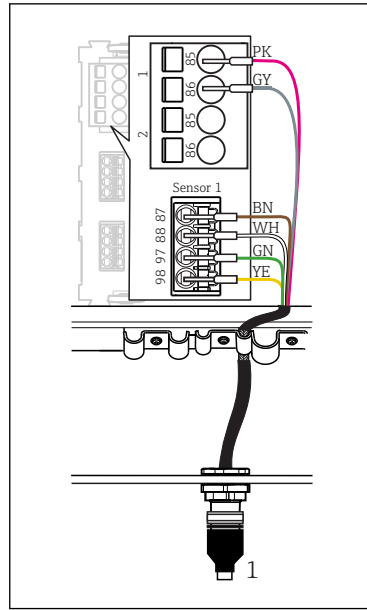

Device versions with a pre-installed M12 socket are ready-wired upon delivery.

Please note the following:

- The internal device wiring is always the same regardless of what kind of sensor you connect to the M12 socket (plug&play).
- The signal or power supply cables are assigned in the sensor head in such a way that the PK and GY power supply cables are either used (e.g. optical sensors) or not (e.g. pH or ORP sensors).

23 M12 plug-in connection (e.g. at sensor module)

1 Sensor cable with M12 connector

24 M12 assignment Top: socket Bottom: connector (top view in each case)

- 1 PK (24 V)
- 2 GY (Ground 24 V)
- 3 BN (3 V)
- 4 WH (Ground 3 V)
- 5 GN (Memosens)
- 6 YE (Memosens)
- 7, NC Not connected

Performance characteristics

| | |
|--|---|
| Response time | <p>Current outputs t_{90} = max. 500 ms for an increase from 0 to 20 mA</p> <p>Current inputs t_{90} = max. 330 ms for an increase from 0 to 20 mA</p> <p>Digital inputs and outputs t_{90} = max. 330 ms for an increase from low to high</p> |
| Reference temperature | 25 °C (77 °F) |
| Measured error for sensor inputs | → Documentation of the connected sensor |
| Measured error for current inputs and outputs | <p>Typical measured errors: < 20 µA (with current values < 4 mA) < 50 µA (with current values 4 to 20 mA) at 25 °C (77 °F) each</p> <p>Additional measured error depending on the temperature: < 1.5 µA/K</p> |
| Frequency tolerance of digital inputs and outputs | ≤ 1% |
| Resolution of current inputs and outputs | < 5 µA |
| Repeatability | → Documentation of the connected sensor |

Installation

Installation conditions

Mounting plate

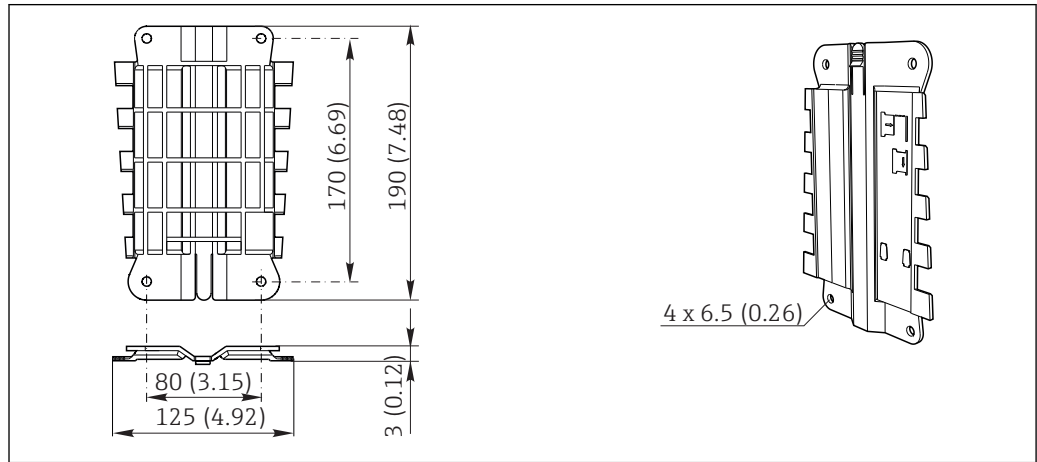

A0012426

25 Mounting plate, dimensions in mm (in)

Weather protection cover

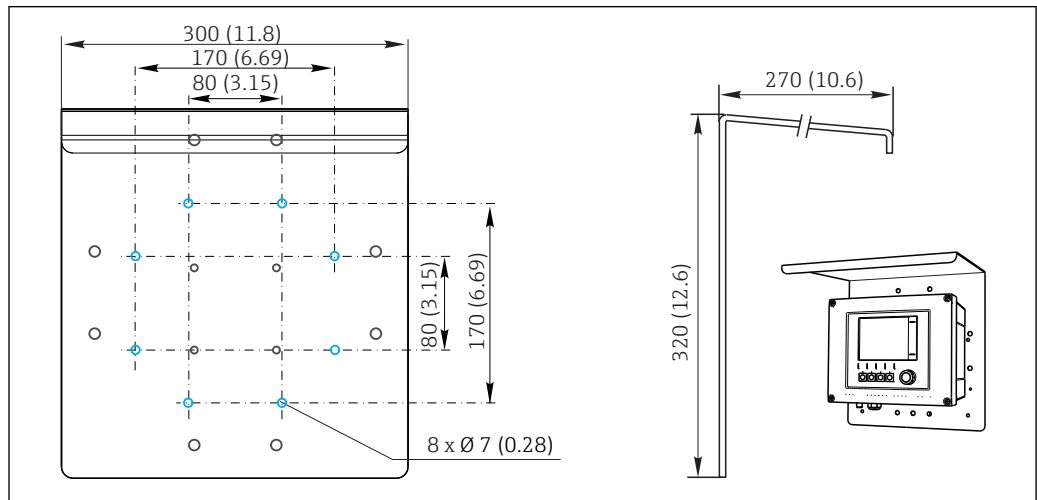

A0012428

26 Dimensions in mm (in)

Installation

Post mounting

i You require the post mounting kit (optional) to mount the unit on a pipe, post or railing (square or circular, clamping range 20 to 61 mm (0.79 to 2.40")).

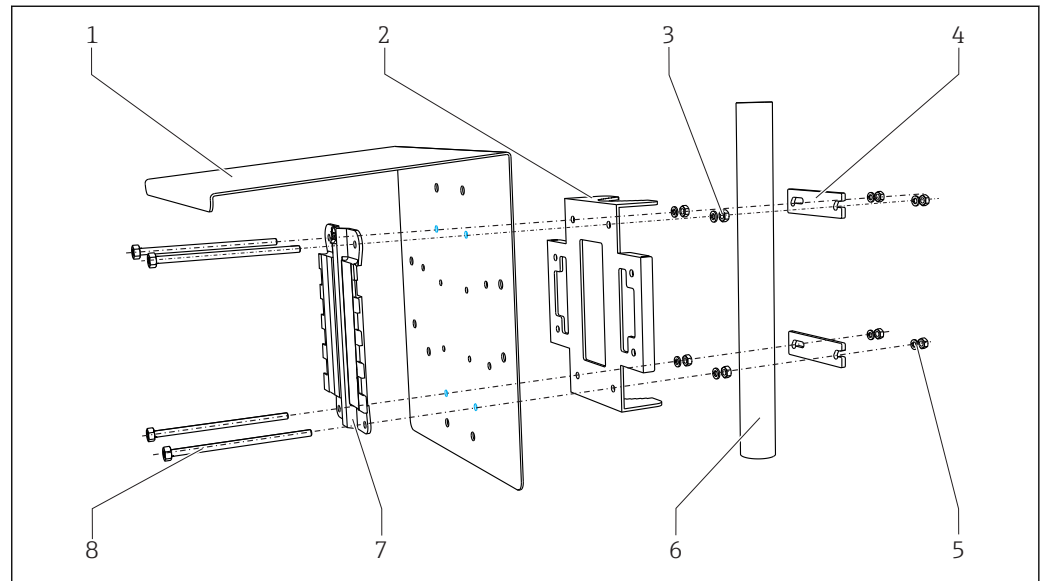

A0033044

27 Post mounting

- | | | | |
|---|---|---|---|
| 1 | Weather protection cover (optional) | 5 | Spring washers and nuts (post mounting kit) |
| 2 | Post mounting plate (post mounting kit) | 6 | Pipe or railing (circular/square) |
| 3 | Spring washers and nuts (post mounting kit) | 7 | Mounting plate |
| 4 | Pipe clamps (post mounting kit) | 8 | Threaded rods (post mounting kit) |

Rail mounting

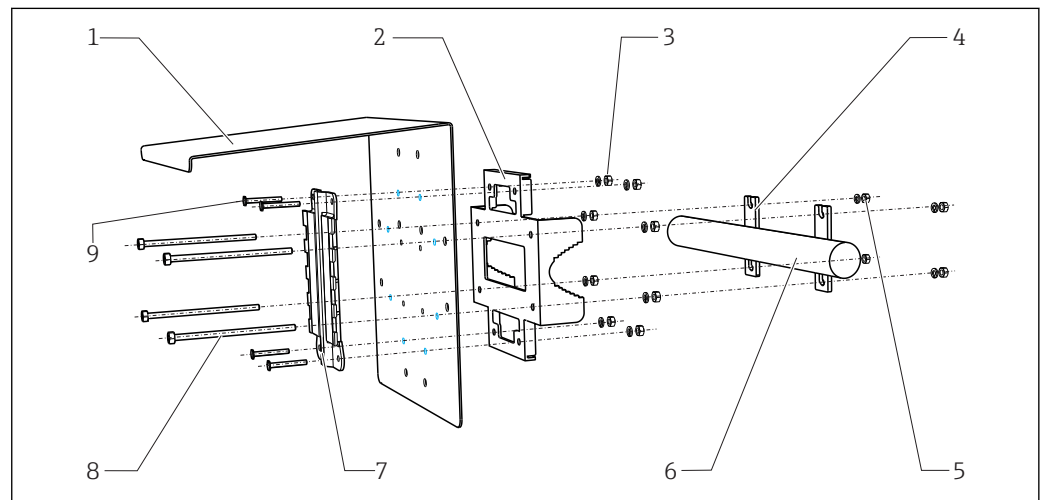

A0012668

28 Rail mounting

- | | | | |
|---|---|---|-----------------------------------|
| 1 | Weather protection cover (optional) | 6 | Pipe or railing (circular/square) |
| 2 | Post mounting plate (post mounting kit) | 7 | Mounting plate |
| 3 | Spring washers and nuts (post mounting kit) | 8 | Threaded rods (post mounting kit) |
| 4 | Pipe clamps (post mounting kit) | 9 | Screws (post mounting kit) |
| 5 | Spring washers and nuts (post mounting kit) | | |

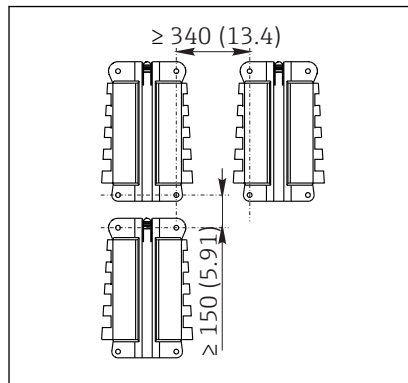
Wall mounting

29 Installation clearance in mm (in)

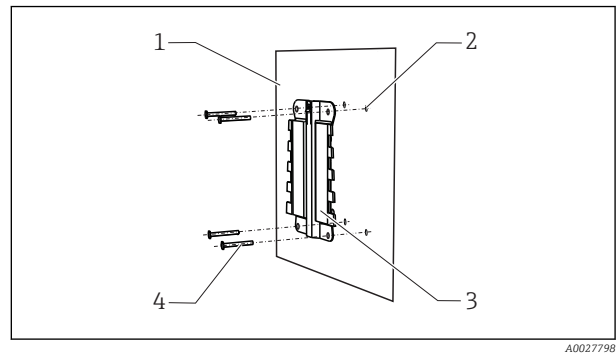

30 Wall mounting

- 1 Wall
- 2 4 drill holes ¹⁾
- 3 Mounting plate
- 4 Screws Ø 6 mm (not part of scope of supply)

¹⁾The size of the drill holes depends on the wall plugs used. The wall plugs and screws must be provided by the customer.

Environment**Ambient temperature range****CM442**

-20 to 60 °C (0 to 140 °F)

CM444

- Generally -20 to 55 °C (0 to 130 °F), with the exception of packages under the second list item
- -20 to 50 °C (0 to 120 °F) for the following packages:

- CM444-**M40A7FI*****+...
- CM444-**M40A7FK*****+...
- CM444-**N40A7FI*****+...
- CM444-**N40A7FK*****+...
- CM444-**M4AA5F4*****+...
- CM444-**M4AA5FF*****+...
- CM444-**M4AA5FH*****+...
- CM444-**M4AA5FI*****+...
- CM444-**M4AA5FK*****+...
- CM444-**M4AA5FM*****+...
- CM444-**M4BA5F4*****+...
- CM444-**M4BA5FF*****+...
- CM444-**M4BA5FH*****+...
- CM444-**M4BA5FI*****+...
- CM444-**M4BA5FK*****+...
- CM444-**M4BA5FM*****+...
- CM444-**M4DA5F4*****+...
- CM444-**M4DA5FF*****+...
- CM444-**M4DA5FH*****+...
- CM444-**M4DA5FI*****+...
- CM444-**M4DA5FK*****+...
- CM444-**M4DA5FM*****+...

CM448

- Generally -20 to 55 °C (0 to 130 °F), with the exception of packages under the second list item
- -20 to 50 °C (0 to 120 °F) for the following packages:
 - CM448-***6AA*****+...
 - CM448-***8A4*****+...
 - CM448-***8A5*****+...
 - CM448-**28A3*****+...
 - CM448-**38A3*****+...
 - CM448-**48A3*****+...
 - CM448-**58A3*****+...
 - CM448-**68A3*****+...
 - CM448-**26A5*****+...
 - CM448-**36A5*****+...
 - CM448-**46A5*****+...
 - CM448-**56A5*****+...
 - CM448-**66A5*****+...
 - CM448-**22A7*****+...
 - CM448-**32A7*****+...
 - CM448-**42A7*****+...
 - CM448-**52A7*****+...
 - CM448-**62A7*****+...
 - CM448-**A6A5*****+...
 - CM448-**A6A7*****+...
 - CM448-**B6A5*****+...
 - CM448-**B6A7*****+...
 - CM448-**C6A5*****+...
 - CM448-**C6A7*****+...
 - CM448-**D6A5*****+...
 - CM448-**D6A7*****+...

| | | | | | | | | | | | | | | | | | | | | | | | | | | | |
|--------------------------------------|--|---------------------|--|-----------------|---------------------------|--|-----------|----------------|---------|--|-----------------|-------------------|---------------|---|--|-----------------|---------------------------|--|-----------|----------------|---------|--|-----------------|---------------------|---------------|---|--|
| Storage temperature | -40 to +80 °C (-40 to 175 °F) | | | | | | | | | | | | | | | | | | | | | | | | | | |
| Humidity | 10 to 95 %, non-condensating | | | | | | | | | | | | | | | | | | | | | | | | | | |
| Degree of protection | IP 66/67, impermeability and corrosion resistance in accordance with NEMA TYPE 4X | | | | | | | | | | | | | | | | | | | | | | | | | | |
| Vibration resistance | <p>Environmental tests Vibration test based on DIN EN 60068-2, October 2008 Vibration test based on DIN EN 60654-3, August 1998</p> <p>Post or pipe mounting</p> <table border="0"> <tr> <td>Frequency range</td> <td colspan="2">10 to 500 Hz (sinusoidal)</td> </tr> <tr> <td>Amplitude</td> <td>10 to 57.5 Hz:</td> <td>0.15 mm</td> </tr> <tr> <td></td> <td>57.5 to 500 Hz:</td> <td>2 g¹⁾</td> </tr> <tr> <td>Test duration</td> <td colspan="2">10 frequency cycles/ spatial axis, in 3 spatial axes (1 oct./min)</td> </tr> </table> <p>Wall mounting</p> <table border="0"> <tr> <td>Frequency range</td> <td colspan="2">10 to 150 Hz (sinusoidal)</td> </tr> <tr> <td>Amplitude</td> <td>10 to 12.9 Hz:</td> <td>0.75 mm</td> </tr> <tr> <td></td> <td>12.9 to 150 Hz:</td> <td>0.5 g¹⁾</td> </tr> <tr> <td>Test duration</td> <td colspan="2">10 frequency cycles/ spatial axis, in 3 spatial axes (1 oct./min)</td> </tr> </table> <p>1) g ... gravitational acceleration (1 g ≈ 9.81 m/s²)</p> | | | Frequency range | 10 to 500 Hz (sinusoidal) | | Amplitude | 10 to 57.5 Hz: | 0.15 mm | | 57.5 to 500 Hz: | 2 g ¹⁾ | Test duration | 10 frequency cycles/ spatial axis, in 3 spatial axes (1 oct./min) | | Frequency range | 10 to 150 Hz (sinusoidal) | | Amplitude | 10 to 12.9 Hz: | 0.75 mm | | 12.9 to 150 Hz: | 0.5 g ¹⁾ | Test duration | 10 frequency cycles/ spatial axis, in 3 spatial axes (1 oct./min) | |
| Frequency range | 10 to 500 Hz (sinusoidal) | | | | | | | | | | | | | | | | | | | | | | | | | | |
| Amplitude | 10 to 57.5 Hz: | 0.15 mm | | | | | | | | | | | | | | | | | | | | | | | | | |
| | 57.5 to 500 Hz: | 2 g ¹⁾ | | | | | | | | | | | | | | | | | | | | | | | | | |
| Test duration | 10 frequency cycles/ spatial axis, in 3 spatial axes (1 oct./min) | | | | | | | | | | | | | | | | | | | | | | | | | | |
| Frequency range | 10 to 150 Hz (sinusoidal) | | | | | | | | | | | | | | | | | | | | | | | | | | |
| Amplitude | 10 to 12.9 Hz: | 0.75 mm | | | | | | | | | | | | | | | | | | | | | | | | | |
| | 12.9 to 150 Hz: | 0.5 g ¹⁾ | | | | | | | | | | | | | | | | | | | | | | | | | |
| Test duration | 10 frequency cycles/ spatial axis, in 3 spatial axes (1 oct./min) | | | | | | | | | | | | | | | | | | | | | | | | | | |
| Electromagnetic compatibility | Interference emission and interference immunity as per EN 61326-1:2013, Class A for Industry | | | | | | | | | | | | | | | | | | | | | | | | | | |
| Electrical safety | IEC 61010-1, Class I equipment Low voltage: overvoltage category II Environment < 3000 m (< 9840 ft) above MSL | | | | | | | | | | | | | | | | | | | | | | | | | | |
| Degree of contamination | The product is suitable for pollution degree 4. | | | | | | | | | | | | | | | | | | | | | | | | | | |

Pressure compensation to environment

Filter made of GORE-TEX used as pressure compensation element
Ensures pressure compensation to environment and guarantees IP protection.

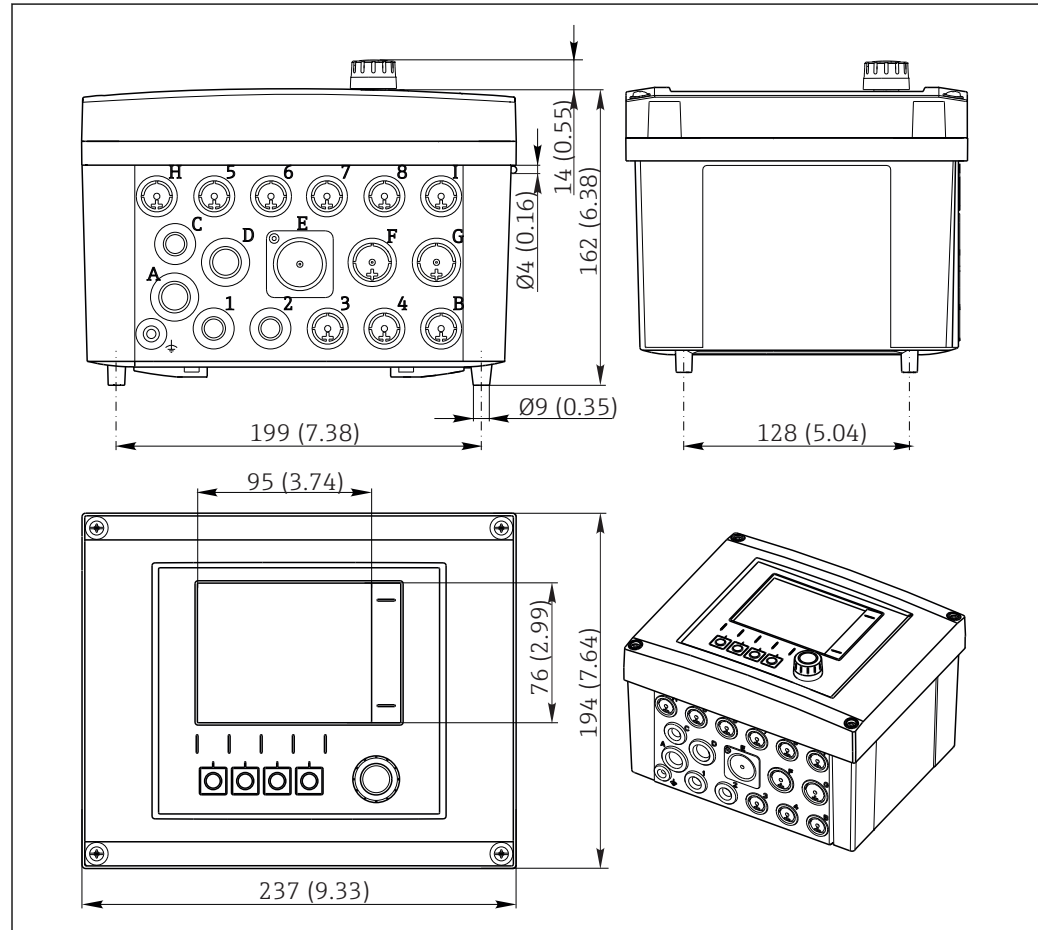
Mechanical construction**Dimensions**

A0012396

31 Dimensions of field housing in mm (inch)

Weight

| | |
|-------------------|---|
| Complete device | Approx. 2.1 kg (4.63 lbs), depending on the version |
| Individual module | Approx. 0.06 kg (0.13 lbs) |
| SD card | Max. 5 g (0.17 oz) |

Materials

| | |
|----------------------------|---|
| Housing base | PC-FR |
| Display cover | PC-FR |
| Display foil and soft keys | PE |
| Housing seal | EPDM |
| Module side panels | PC-FR |
| Module covers | PBT GF30 FR |
| Cable mounting rail | PBT GF30 FR, stainless steel 1.4301 (AISI304) |
| Clamps | Stainless steel 1.4301 (AISI304) |
| Threaded fasteners | Stainless steel 1.4301 (AISI304) |
| Cable glands | Polyamide V0 as per UL94 |

Operability

display

Graphic display:

- Resolution: 240 x 160 pixel
- Back light with switch-off function
- Red display background for alarms alerts users to errors
- Transflective display technology for maximum contrast even in bright environments
- User-definable measuring menus mean you can always keep track of the values that are important for your application.

Operating concept

The simple and structured operating concept sets new standards:

- Intuitive operation with the navigator and soft keys
- Fast configuration of application-specific measurement options
- Easy configuration and diagnosis thanks to plain-text display
- All languages that can be ordered are available in every device



A0025228

32 Easy operation

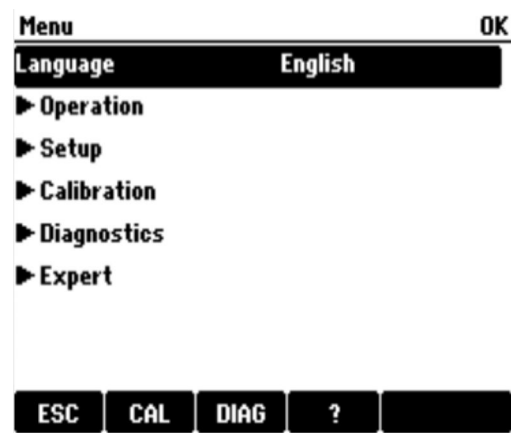

33 Plain-text menu

Local operation

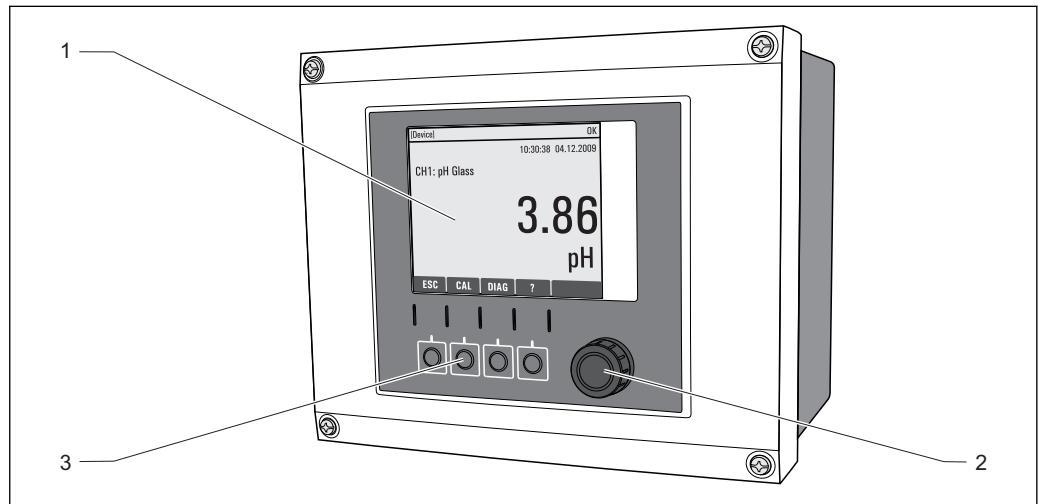

A0011764

34 Overview of operation

- 1 Display (with red display background in alarm condition)
- 2 Navigator (jog/shuttle and press/hold function)
- 3 Soft keys (function depends on menu)

Remote operation

Via HART (e.g. using HART modem and FieldCare)

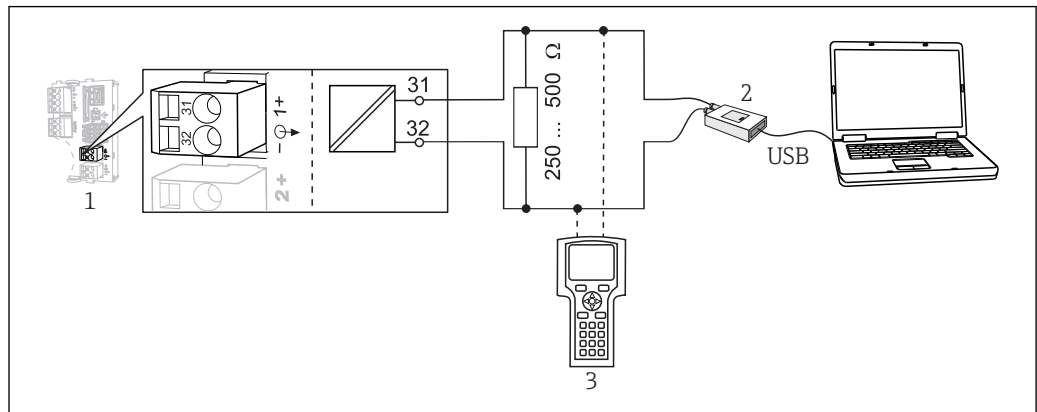

A0028995

35 HART using modem

- 1 Device module Base L, H or E: current output 1 with HART
 - 2 HART modem for connection to PC, e.g. Commubox FXA191 (RS232) or FXA195 ¹⁾ (USB)
 - 3 HART handheld terminal
- ¹⁾ Switch position "on" (substitutes the resistor)

Via PROFIBUS DP

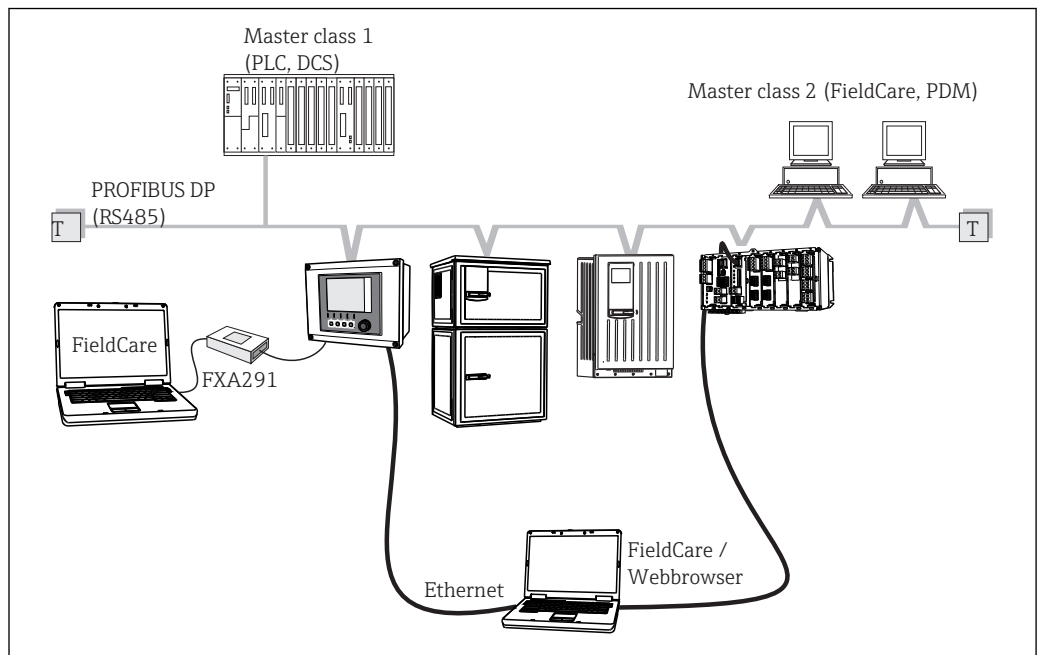

A0028991

36 PROFIBUS DP

- T Terminating resistor

Via Modbus RS485

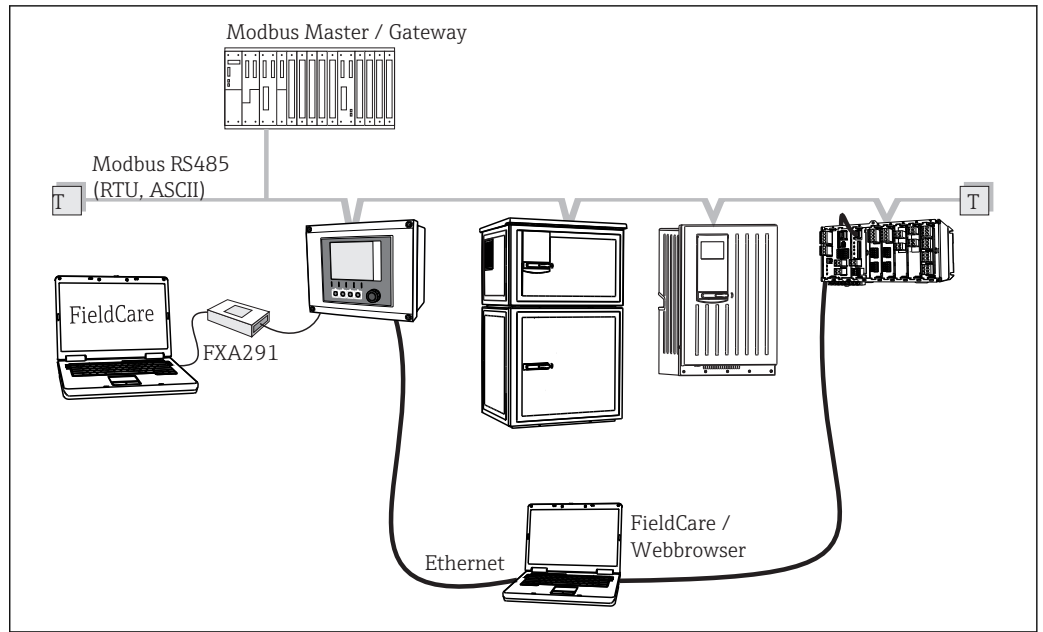

A0028993

37 Modbus RS485

T Terminating resistor

Via Ethernet/Web server/Modbus TCP/EtherNet/IP

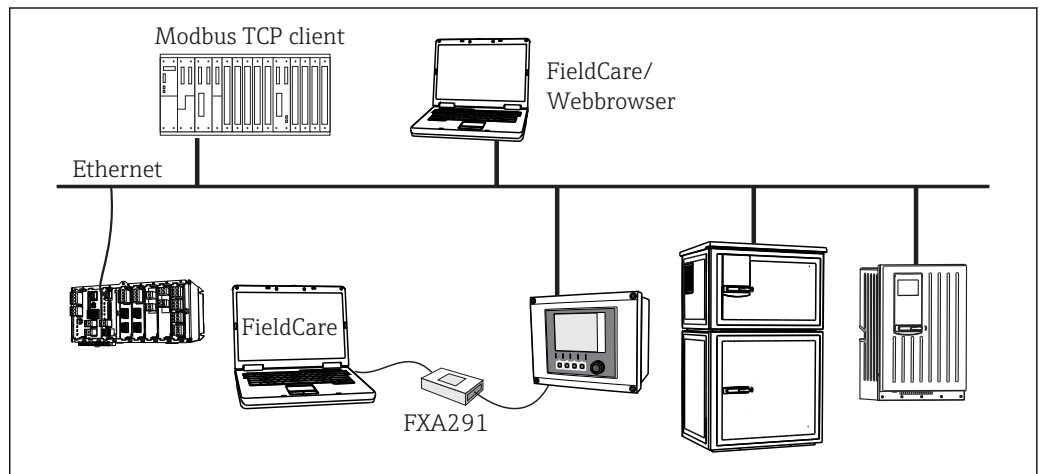

A0028994

38 Modbus TCP and/or EtherNet/IP

Language packages

The language selected in the product structure is the operating language preset at the factory. All other languages can be selected using the menu.

- English (US)
- German
- Chinese (Simplified, PR China)
- Czech
- Dutch
- French
- Italian
- Japanese
- Polish
- Portuguese
- Russian
- Spanish
- Swedish

- Turkish
- Hungarian
- Croatian
- Vietnamese

The availability of other languages can be checked via the product structure at www.endress.com/cm442 or [.../cm444](http://www.endress.com/cm444) or [.../cm448](http://www.endress.com/cm448).

Certificates and approvals

| | |
|----------------|---|
| CE mark | The product meets the requirements of the harmonized European standards. As such, it complies with the legal specifications of the EU directives. The manufacturer confirms successful testing of the product by affixing to it the CE mark. |
| EAC | The product has been certified according to guidelines TP TC 004/2011 and TP TC 020/2011 which apply in the European Economic Area (EEA). The EAC conformity mark is affixed to the product. |
| cCSAus | <p>The device has been certified with regard to its electrical safety and for NI Class I Div. 2 cCSAus explosion-proof environments. It meets the requirements in accordance with:</p> <ul style="list-style-type: none"> ▪ CLASS 2252 06 - Process Control Equipment ▪ CLASS 2252 86 - Process Control Equipment - Certified to US Standards ▪ CLASS 2258 03 - Process Control Equipment - Intrinsically Safe and Non-incendive Systems - For Hazardous Locations ▪ CLASS 2258 83 - Process Control Equipment - Intrinsically Safe and Non-incendive Systems - For Hazardous Locations - Certified to US Standards ▪ FM3600 ▪ FM3611 ▪ FM3810 ▪ ANSI/ISA NEMA250 ▪ IEC 60529 ▪ CAN/CSA-C22.2 No. 0 ▪ CAN/CSA C22.2 No. 94 ▪ CSA Std. C22.2 No. 213 ▪ CAN/CSA-C22.2 No. 61010-1 ▪ CAN/CSA-C22.2 No. 60529 ▪ UL/ANSI/ISA 61010-1 ▪ ANSI - ISA 12 12 01 |
| MCERTS | <p>CM442 only</p> <p>The device has been assessed by Sira Certification Service and complies with "MCERTS Performance Standards for Continuous Water Monitoring Equipment, Part 2: online analysers, Version 3.1, dated August 2010"; Certificate No.: Sira MC140246/01.</p> |

Ordering information

| | |
|-----------------------------|---|
| Product page | <p>www.endress.com/cm442</p> <p>www.endress.com/cm444</p> <p>www.endress.com/cm448</p> |
| Product Configurator | <p>On the product page there is a Configure button to the right of the product image.</p> <ol style="list-style-type: none"> 1. Click this button. <ul style="list-style-type: none"> ↳ The Configurator opens in a separate window. 2. Select all the options to configure the device in line with your requirements. <ul style="list-style-type: none"> ↳ In this way, you receive a valid and complete order code for the device. |

3. Export the order code as a PDF or Excel file. To do so, click the appropriate button on the right above the selection window.

 For many products you also have the option of downloading CAD or 2D drawings of the selected product version. Click the **CAD** tab for this and select the desired file type using picklists.

Scope of delivery

The scope of delivery comprises:

- 1 multichannel controller in the version ordered
- 1 mounting plate
- 1 wiring label (attached at the factory to the inside of the display cover)
- 1 printed copy of the Brief Operating Instructions in the language ordered

Accessories

The following are the most important accessories available at the time this documentation was issued.

- ▶ For accessories not listed here, please contact your Service or Sales Center.

Protective cover

CYY101

- Weather protection cover for field devices
- Absolutely essential for field installation
- Material: stainless steel 1.4301 (AISI 304)
- Order No. CYY101-A

Post mounting kit

Post mounting kit CM44x

- For securing the field housing to horizontal and vertical posts and pipes
- Order No. 71096920

Measuring cable

Memosens data cable CYK10

- For digital sensors with Memosens technology
- Product Configurator on the product page: www.endress.com/cyk10

 Technical Information TI00118C

Memosens data cable CYK11

- Extension cable for digital sensors with Memosens protocol
- Product Configurator on the product page: www.endress.com/cyk11

 Technical Information TI00118C

Sensors

Glass electrodes

Orbisint CPS11D

- pH sensor for process technology
- Optional SIL version for connecting to SIL transmitter
- With dirt-repellent PTFE diaphragm
- Product Configurator on the product page: www.endress.com/cps11d

 Technical Information TI00028C

Memosens CPS31D

- pH electrode with gel-filled reference system with ceramic diaphragm
- Product Configurator on the product page: www.endress.com/cps31d

 Technical Information TI00030C

Ceraliquid CPS41D

- pH electrode with ceramic junction and KCl liquid electrolyte
- Product Configurator on the product page: www.endress.com/cps41d

 Technical Information TI00079C

Ceragel CPS71D

- pH electrode with reference system including ion trap
- Product Configurator on the product page: www.endress.com/cps71d



Technical Information TI00245C

Memosens CPS171D

- pH electrode for bio-fermenters with digital Memosens technology
- Product Configurator on the product page: www.endress.com/cps171d



Technical Information TI01254C

Orbipore CPS91D

- pH electrode with open aperture for media with high dirt load
- Product Configurator on the product page: www.endress.com/cps91d



Technical Information TI00375C

Orbipac CPF81D

- Compact pH sensor for installation or immersion operation
- In industrial water and wastewater
- Product Configurator on the product page: www.endress.com/cpf81d



Technical Information TI00191C

Enamel pH electrodes**Ceramax CPS341D**

- pH electrode with pH-sensitive enamel
- Meets highest demands of measuring accuracy, pressure, temperature, sterility and durability
- Product Configurator on the product page: www.endress.com/cps341d



Technical Information TI00468C

ORP sensors**Orbisint CPS12D**

- ORP sensor for process technology
- Product Configurator on the product page: www.endress.com/cps12d



Technical Information TI00367C

Ceraliquid CPS42D

- ORP electrode with ceramic junction and KCl liquid electrolyte
- Product Configurator on the product page: www.endress.com/cps42d



Technical Information TI00373C

Ceragel CPS72D

- ORP electrode with reference system including ion trap
- Product Configurator on the product page: www.endress.com/cps72d



Technical Information TI00374C

Orbipac CPF82D

- Compact ORP sensor for installation or immersion operation in process water and wastewater
- Product Configurator on the product page: www.endress.com/cpf82d



Technical Information TI00191C

Orbipore CPS92D

- ORP electrode with open aperture for media with high dirt load
- Product Configurator on the product page: www.endress.com/cps92d



Technical Information TI00435C

pH ISFET sensors

Tophit CPS441D

- Sterilizable ISFET sensor for low-conductivity media
- Liquid KCl electrolyte
- Product Configurator on the product page: www.endress.com/cps441d



Technical Information TI00352C

Tophit CPS471D

- Sterilizable and autoclavable ISFET sensor for food and pharmaceuticals, process engineering
- Water treatment and biotechnology
- Product Configurator on the product page: www.endress.com/cps471d



Technical Information TI00283C

Tophit CPS491D

- ISFET sensor with open aperture for media with high dirt load
- Product Configurator on the product page: www.endress.com/cps491d



Technical Information TI00377C

pH and ORP combined sensors

Memosens CPS16D

- Combined pH/ORP sensor for process technology
- With dirt-repellent PTFE diaphragm
- With Memosens technology
- Product Configurator on the product page: www.endress.com/cps16d



Technical Information TI00503C

Memosens CPS76D

- Combined pH/ORP sensor for process technology
- Hygienic and sterile applications
- With Memosens technology
- Product Configurator on the product page: www.endress.com/cps76d



Technical Information TI00506C

Memosens CPS96D

- Combined pH/ORP sensor for chemical processes
- With poison-resistant reference with ion trap
- With Memosens technology
- Product Configurator on the product page: www.endress.com/cps96d



Technical Information TI00507C

Conductivity sensors with inductive measurement of conductivity

Indumax CLS50D

- High-durability inductive conductivity sensor
- For standard and hazardous area applications
- With Memosens technology
- Product Configurator on the product page: www.endress.com/cls50d



Technical Information TI00182C

Indumax H CLS54D

- Inductive conductivity sensor
- With certified, hygienic design for foodstuffs, beverages, pharmaceuticals and biotechnology
- Product Configurator on the product page: www.endress.com/cls54d



Technical Information TI00508C

Conductivity sensors with conductive measurement of conductivity**Condumax CLS15D**

- Conductive conductivity sensor
- For pure water, ultrapure water and hazardous area applications
- Product Configurator on the product page: www.endress.com/CLS15d



Technical Information TI00109C

Condumax CLS16D

- Hygienic, conductive conductivity sensor
- For pure water, ultrapure water and Ex applications
- With EHEDG and 3A approval
- Product Configurator on the product page: www.endress.com/CLS16d



Technical Information TI00227C

Condumax CLS21D

- Two-electrode sensor in plug-in head version version
- Product Configurator on the product page: www.endress.com/CLS21d



Technical Information TI00085C

Memosens CLS82D

- Four-electrode sensor
- With Memosens technology
- Product Configurator on the product page: www.endress.com/cls82d



Technical Information TI01188C

Oxygen sensors**Oxymax COS22D**

- Sterilizable sensor for dissolved oxygen
- With Memosens technology or as an analog sensor
- Product Configurator on the product page: www.endress.com/cos22d



Technical Information TI00446C

Oxymax COS51D

- Amperometric sensor for dissolved oxygen
- With Memosens technology
- Product Configurator on the product page: www.endress.com/cos51d



Technical Information TI00413C

Oxymax COS61D

- Optical oxygen sensor for drinking water and industrial water measurement
- Measuring principle: quenching
- With Memosens technology
- Product Configurator on the product page: www.endress.com/cos61d



Technical Information TI00387C

Memosens COS81D

- Sterilizable, optical sensor for dissolved oxygen
- With Memosens technology
- Product Configurator on the product page: www.endress.com/cos81d



Technical Information TI01201C

Disinfection sensors

CCS142D

- Membrane-covered amperometric sensor for free chlorine
- Measuring range 0.01 to 20 mg/l
- With Memosens technology
- Product Configurator on the product page: www.endress.com/ccs142d



Technical Information TI00419C

Ion-selective sensors

ISEmax CAS40D

- Ion selective sensors
- Product Configurator on the product page: www.endress.com/cas40d



Technical Information TI00491C

Turbidity sensors

Turbimax CUS51D

- For nephelometric measurements of turbidity and solids in wastewater
- 4-beam scattered light method
- With Memosens technology
- Product Configurator on the product page: www.endress.com/cus51d



Technical Information TI00461C

Turbimax CUS52D

- Hygienic Memosens sensor for turbidity measurement in drinking water, process water and in utilities
- With Memosens technology
- Product Configurator on the product page: www.endress.com/cus52d



Technical Information TI01136C

SAC and nitrate sensors

Viomax CAS51D

- SAC and nitrate measurement in drinking water and wastewater
- With Memosens technology
- Product Configurator on the product page: www.endress.com/cas51d



Technical Information TI00459C

Interface measurement

Turbimax CUS71D

- Immersion sensor for interface measurement
- Ultrasonic interface sensor
- Product Configurator on the product page: www.endress.com/cus71d



Technical Information TI00490C

Additional functionality

Hardware extension modules

Kit, extension module AOR

- 2 x relay, 2 x 0/4 to 20 mA analog output
- Order No. 71111053

Kit, extension module 2R

- 2 x relay
- Order No. 71125375

Kit, extension module 4R

- 4 x relay
- Order No. 71125376

Kit, extension module 2AO

- 2 x 0/4 to 20 mA analog output
- Order No. 71135632

Kit, extension module 4AO

- 4 x analog output 0/4 to 20 mA
- Order No. 71135633

Kit, extension module 2DS

- 2 x digital sensor, Memosens
- Order No. 71135631

Kit, extension module 2AI

- 2 x 0/4 to 20 mA analog input
- Order No. 71135639

Kit, extension module DIO

- 2 x digital input
- 2 x digital output
- Auxiliary voltage supply for digital output
- Order No. 71135638

Kit, extension module 485

- Ethernet configuration
- Can be extended to PROFIBUS DP or Modbus RS485 or Modbus TCP or EtherNet/IP. This requires an additional activation code which can be ordered separately.
- Order No. 71135634

Kit, extension module ETH

- Ethernet configuration
- Can be extended to Modbus TCP or EtherNet/IP. This requires an additional activation code which can be ordered separately.
- Order No. 71279810

Upgrade kit, extension module 485 with PROFIBUS DP

- Extension module 485
- PROFIBUS DP (+ Ethernet configuration)
- Order No. 71140888

Upgrade kit, extension module 485 with Modbus RS485

- Extension module 485
- Modbus RS485 (+ Ethernet configuration)
- Order No. 71140889

Upgrade kit, extension module 485 with Modbus TCP

- Extension module 485
- Modbus TCP (+ Ethernet configuration)
- Order No. 71140890

Upgrade kit, extension module 485 with EtherNet/IP

- Extension module 485
- EtherNet/IP (+ Ethernet configuration)
- Order No. 71219868

Upgrade kit, extension module ETH with Modbus TCP

- Extension module ETH
- Modbus TCP (+ Ethernet configuration)
- Order No. 71279809

Upgrade kit, extension module ETH with EtherNet/IP

- Extension module ETH
- EtherNet/IP (+ Ethernet configuration)
- Order No. 71279812

Kit CM442: upgrade kit to CM444/CM448

- Extension power supply unit 100 to 230 V AC and extension backplane
- Base module BASE-E
- You must quote the serial number of the device when ordering the kit.
- Order No. 71135644

Kit CM442: upgrade kit to CM444/CM448

- Extension power supply unit 24 V DC and extension backplane
- Base module BASE-E
- You must quote the serial number of the device when ordering the kit.
- Order No. 71211434

Firmware and activation codes

SD card with Liquiline firmware

- Industrial Flash Drive, 1 GB
- Order No. 71127100



You must quote the serial number of the device when ordering the activation code.

Activation code for digital HART communication

Order No. 71128428

Activation code for PROFIBUS DP

Order No. 71135635

Activation code for Modbus RS485

Order No. 71135636

Activation code for Modbus TCP for module 485

Order No. 71135637

Activation code for EtherNet/IP for module 485

Order No. 71219871

Activation code for Modbus TCP for module ETH

Order No. 71279813

Activation code for EtherNet/IP for module ETH

Order No. 71279830

Kit CM442: activation code for 2nd digital sensor input

Order No. 71114663

Kit CM444/CM448: upgrade code for 2 x 0/4 to 20 mA for BASE-E

Order No. 71140891

Activation code for feedforward control

- Requires current input or fieldbus communication
- Order No. 71211288

Activation code for measuring range switch

- Requires digital inputs or fieldbus communication
- Order No. 71211289

Activation code for ChemocleanPlus

- Requires relays or digital outputs or fieldbus communication and optional digital inputs
- Order No. 71239104

Activation code for Heartbeat Verification and Monitoring

Order No. 71367524

Activation code for ion exchanger operating time

- Mathematical function
- Order No. 71367531

Activation code for mathematics

- Formula editor
- Order No. 71367541

Activation code for remote calibration interface

Order No. 71367542

Software

Memobase Plus CYZ71D

- PC software to support laboratory calibration
- Visualization and documentation of sensor management
- Sensor calibrations stored in database
- Product Configurator on the product page: www.endress.com/cyz71d



Technical Information TI00502C

Field Data Manager Software MS20

- PC software for central data management
- Visualization of series of measurements and logbook events
- SQL database for secure data storage

Other accessories**SD card**

- Industrial Flash Drive, 1 GB
- Weight: 2 g
- Order No. 71110815

Cable glands**Kit CM44x: gland M**

- Set, 6 pieces
- Order No. 71101768

Kit CM44x: gland NPT

- Set, 6 pieces
- Order No. 71101770

Kit CM44x: gland G

- Set, 6 pieces
- Order No. 71101771

Kit CM44x: dummy plug for cable gland

- Set, 6 pieces
- Order No. 71104942

M12 built-in socket and cable junction with Velcro strip**Kit CM42/CM442/CM444/CM448: external CDI socket**

- Socket with terminated connecting cables and counter nut
- Order No. 51517507

Kit CM442/CM444/CM448/CSF48: M12 built-in socket for digital sensors

- Pre-terminated
- Order No. 71107456

Kit CM442/CM444/CM448/CSF48: M12 built-in socket for PROFIBUS DP/Modbus RS485

- B-coded, pre-terminated
- Order No. 71140892

Kit CM442/CM444/CM448/CSF48: M12 built-in socket for Ethernet

- D-coded, pre-terminated
- Order No. 71140893

Kit: external CDI socket, complete

- Retrofit kit for CDI interface, with terminated connecting cables
- Order No. 51517507

Cable junction with Velcro strip

- 4 pieces, for sensor cable
- Order No. 71092051

Communication-specific accessories**Commubox FXA191**

- Intrinsically safe HART communication with FieldCare via the RS232C interface
- Transforms HART signals on RS 232C interface



Technical Information TI00237F

Commubox FXA195

Intrinsically safe HART communication with FieldCare via the USB port



Technical Information TI00404F

Commubox FXA291

Connects the CDI interface of measuring devices with the USB port of the computer or laptop



Technical Information TI00405C

Wireless HART adapter SWA70

- Wireless device connection
- Easily integrated, offers data protection and transmission safety, can be operated in parallel with other wireless networks, minimum cabling complexity



Technical Information TI00061S

Fieldgate FXA320

Gateway for the remote interrogation of 4-20 mA measuring devices via a Web browser



Technical Information TI00025S

FieldXpert SFX100

Compact, flexible and robust industrial handheld terminal for remote configuration and for obtaining measured values via the HART current output



Operating Instructions BA00060S

System components

RIA14, RIA16

- Field display unit for integration into 4-20 mA circuits
- RIA14 in flameproof metal enclosure



Technical Information TI00143R and TI00144R

RIA15

- Process display unit, Digital display unit for integration into 4-20 mA circuits
- Panel mounting
- With optional HART communication



Technical Information TI01043K

www.addresses.endress.com
